



**BASIC MANUAL**

HF/50 MHz TRANSCEIVER  
**IC-7300**



Thank you for choosing this Icom product. The IC-7300 HF/50 MHz TRANSCEIVER is designed and built with Icom's state of the art technology and craftsmanship. With proper care, this product should provide you with years of trouble-free operation. We appreciate you making the IC-7300 your transceiver of choice, and hope you agree with Icom's philosophy of "technology first." Many hours of research and development went into the design of your IC-7300.

## IMPORTANT

**READ ALL INSTRUCTIONS** carefully completely before using the transceiver.

**SAVE THIS INSTRUCTION MANUAL**— This instruction manual contains full operating instructions for the IC-7300.

## FEATURES

- **RF Direct Sampling System**

The IC-7300 employs an RF direct sampling system. RF signals are directly converted to digital data and processed in the FPGA. This system is a leading technology marking an epoch in amateur radio.

- **Real-Time Spectrum Scope**

The spectrum scope is class-leading in resolution, sweep speed and dynamic range. When you touch the scope screen on the intended signal, the touched area is magnified. The large 4.3 inch color TFT touch LCD offers intuitive operation.

- **New "IP+" Function**

The new IP Plus function improves 3rd order intercept point (IP3) performance. When a weak signal is received adjacent to strong interference, the AD converter is optimized against signal distortion.

- **Class Leading RMDR and Phase Noise Characteristics**

The RMDR is improved to about 97dB (typical value) and Phase Noise characteristics are also improved about 15dB (at 1 kHz frequency separation) compared to the IC-7200.

- **A 4.3 inch touch panel color display**

- **A built-in automatic antenna tuner**

- **Multi-function control for easy settings**

## EXPLICIT DEFINITIONS

WORD	DEFINITION
<b>⚠ DANGER!</b>	Personal death, serious injury or an explosion may occur.
<b>⚠ WARNING!</b>	Personal injury, fire hazard or electric shock may occur.
<b>CAUTION</b>	Equipment damage may occur.
<b>NOTE</b>	Recommended for optimum use. No risk of personal injury, fire or electric shock.

## SUPPLIED ACCESSORIES

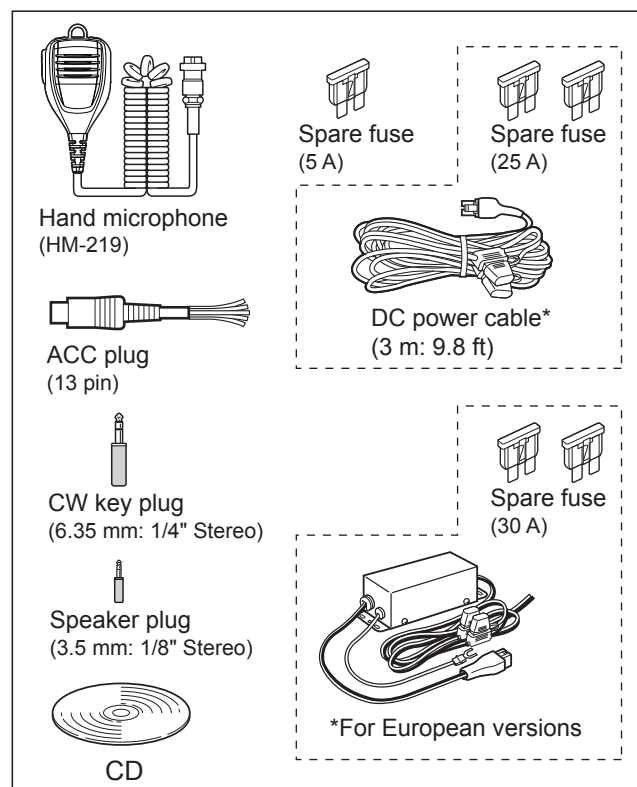

ⓘ Different types of accessories may be supplied, or may not be supplied depending on the transceiver version.

This product includes RTOS "RTX" software, and is licensed according to the software license.

This product includes "zlib" open source software, and is licensed according to the open source software license.

This product includes "libpng" open source software, and is licensed according to the open source software license.

Refer to the Text files in the License folder of included CD for information on the open source software being used by this product.

---

## FCC INFORMATION

---

### • FOR CLASS B UNINTENTIONAL RADIATORS:

This equipment has been tested and found to comply with the limits for a Class B digital device, pursuant to part 15 of the FCC Rules. These limits are designed to provide reasonable protection against harmful interference in a residential installation. This equipment generates, uses and can radiate radio frequency energy and, if not installed and used in accordance with the instructions, may cause harmful interference to radio communications. However, there is no guarantee that interference will not occur in a particular installation. If this equipment does cause harmful interference to radio or television reception, which can be determined by turning the equipment off and on, the user is encouraged to try to correct the interference by one or more of the following measures:

- Reorient or relocate the receiving antenna.
- Increase the separation between the equipment and receiver.
- Connect the equipment into an outlet on a circuit different from that to which the receiver is connected.
- Consult the dealer or an experienced radio/TV technician for help.

This device complies with Part 15 of the FCC Rules. Operation is subject to the following two conditions: (1) this device may not cause harmful interference, and (2) this device must accept any interference received, including interference that may cause undesired operation.

**WARNING:** MODIFICATION OF THIS DEVICE TO RECEIVE CELLULAR RADIOTELEPHONE SERVICE SIGNALS IS PROHIBITED UNDER FCC RULES AND FEDERAL LAW.

**CAUTION:** Changes or modifications to this device, not expressly approved by Icom Inc., could void your authority to operate this device under FCC regulations.

---

## TRADEMARKS

---

Icom, Icom Inc. and the Icom logo are registered trademarks of Icom Incorporated (Japan) in Japan, the United States, the United Kingdom, Germany, France, Spain, Russia, Australia, New Zealand and/or other countries.

Microsoft, Windows and Windows Vista are registered trademarks of Microsoft Corporation in the United States and/or other countries.

Adobe and Adobe Reader are registered trademark of Adobe Systems Incorporated.

All other products or brands are registered trademarks or trademarks of their respective holders.

## DISPOSAL



The crossed-out wheeled-bin symbol on your product, literature, or packaging reminds you that in the European Union, all electrical and electronic products, batteries, and accumulators (rechargeable batteries) must be taken to designated collection locations at the end of their working life. Do not dispose of these products as unsorted municipal waste.

Dispose of them according to the laws in your area.

Icom is not responsible for the destruction or damage to the Icom transceiver, if the malfunction is because of:

- Force majeure, including, but not limited to, fires, earthquakes, storms, floods, lightnings, or other natural disasters, disturbances, riots, war, or radioactive contamination.
- The use of Icom transceiver with any equipment that is not manufactured or approved by Icom.

---

## ABOUT THE TOUCH SCREEN

---

### ◇ Touch operation

In the Full manual or Basic manual, the touch operation is described as shown below.



#### Touch

If the display is touched briefly, one short beep sounds.



#### Touch for 1 second

If the display is touched for 1 second, one short and one long beep sound.

### ◇ Touch screen precautions

- The touch screen may not properly work when the LCD protection film or sheet is attached.
- Touching the screen with your finger nails, sharp topped object and so on, or touching the screen hard may damage it.
- Tablet PC's operations such as flick, pinch in and pinch out cannot be performed on this touch screen.

### ◇ Touch screen maintenance

- If the touch screen becomes dusty or dirty, wipe it clean with a soft, dry cloth.
- When you wipe the touch screen, be careful not to push it too hard or scratch it with your finger nails. Otherwise you may damage the screen.

---

## ABOUT THE SUPPLIED CD

---

The following items are included on the CD.

- **Full manual (English)**  
Instructions for full operations, the same as this manual.
- **Basic manual (English)**  
Instructions for basic operations, the same the manual supplied with the transceiver.
- **Basic manual (German, Spanish, French, Italian, and other)**  
Instructions for basic operations in German, Spanish, French, Italian, and other languages. This manual may not be included, depending on the transceiver version.
- **Schematic diagram**  
Includes the schematic and block diagrams.
- **HAM radio Terms**  
A glossary of HAM radio terms.
- **Adobe® Reader® Installer**  
Installer for Adobe® Reader®.

To read the manuals or Schematic diagram, Adobe® Reader® is required. If you have not installed it, please install the Adobe® Reader® on the CD or download it from Adobe Systems Incorporated's website.

A PC with the following Operating System is required.

- Microsoft® Windows® 10
- Microsoft® Windows® 8.1
- Microsoft® Windows® 7
- Microsoft® Windows Vista®

### Starting the CD

1. Insert the CD into the CD drive.
2. Double click "Menu.exe" on the CD.
  - Depending on the PC setting, the menu screen shown below is automatically displayed.
3. Click the desired button to open the file.  
① To close the Menu screen, click [Quit].

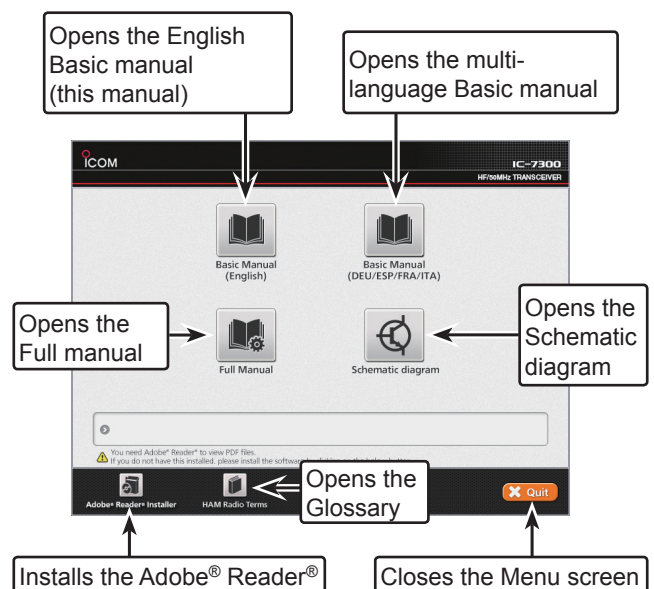

- ① Different types of menu screen may be displayed, depending on the transceiver version.



# ABOUT THE INSTRUCTIONS

The Full and Basic manuals are described based on the following manner.

**“ ” (Quotation marks):**

Used to indicate icons, setting items, and screen\* titles displayed on the screen.

**[ ] (brackets):**

Used to indicate keys.

\* The screen titles are also indicated in uppercase letters. (Example: FUNCTION screen)

**Routes to the set modes and setting screens**

Routes to the set mode, setting screen and the setting items are described in the following manner.

**MENU** » **SET > Display > Display Type**

**Instruction example**

◇ **Selecting the display background**

1. Select the “Display Type” screen.  
**MENU** » **SET > Display > Display Type**
2. Select the desired background between A and B by rotating and then pushing **MULTI**.
  - A: Black background (default)
  - B: Blue background
3. To close the DISPLAY screen, push **EXIT** several times.

**Detailed instruction**

1. Push **MENU**.

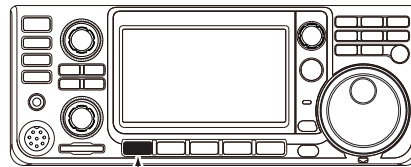

Push

- Opens the MENU screen.

2. Touch **[SET]**.

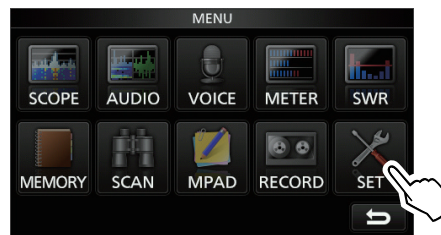

MENU screen

- Opens the SET screen.

3. Rotate **MULTI**, and then push **MULTI** to select “Display.”

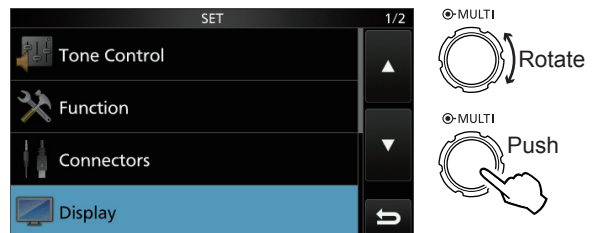

SET screen

4. Rotate **MULTI**, and then push **MULTI** to select “Display Type.”

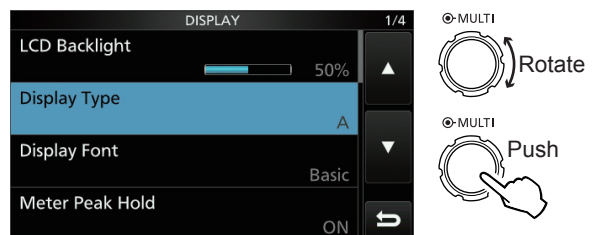

DISPLAY screen

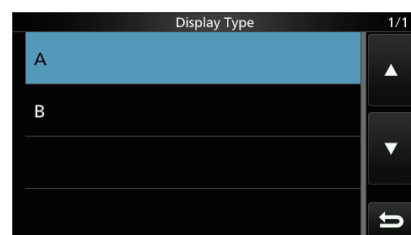

“Display Type” screen

---

# TABLE OF CONTENTS

---

IMPORTANT.....	i	◇ Entering a Band Edge.....	3-6
FEATURES.....	i	RF gain and SQL level .....	3-9
EXPLICIT DEFINITIONS.....	i	Dial Lock function .....	3-9
SUPPLIED ACCESSORIES.....	i	Basic transmission .....	3-9
FCC INFORMATION .....	ii	Adjusting the transmit output power .....	3-9
TRADEMARKS.....	ii	◇ Adjusting the transmit output power .....	3-9
DISPOSAL.....	ii	Meter display .....	3-10
ABOUT THE TOUCH SCREEN .....	iii	◇ Meter display selection .....	3-10
◇ Touch operation.....	iii	◇ Multi-function meter .....	3-10
◇ Touch screen precautions .....	iii	Adjusting the microphone gain .....	3-10
◇ Touch screen maintenance .....	iii	About the 5 MHz frequency band operation (USA version only).....	3-11
ABOUT THE SUPPLIED CD .....	iii		
ABOUT THE INSTRUCTIONS .....	iv	<b>4 RECEIVING AND TRANSMITTING.....</b>	<b>4-1</b>
PRECAUTIONS.....	vii	Preamplifiers .....	4-1
<b>1 PANEL DESCRIPTION .....</b>	<b>1-1</b>	Attenuator.....	4-1
Front panel .....	1-1	RIT function .....	4-1
Rear panel.....	1-3	◇ RIT monitor function .....	4-1
Touch panel display.....	1-4	AGC function control .....	4-2
◇ Multi-function menus.....	1-6	◇ Selecting the AGC time constant preset value .....	4-2
◇ MENU screen .....	1-6	◇ Setting the AGC time constant.....	4-2
◇ FUNCTION screen .....	1-6	Using the Twin PBT .....	4-3
◇ QUICK MENU.....	1-6	Selecting the IF filter.....	4-4
Keyboard entering and editing .....	1-7	Selecting the IF filter shape.....	4-4
◇ Entering and editing characters.....	1-7	IP Plus function .....	4-5
◇ Keyboard types.....	1-7	Noise Blanker .....	4-5
◇ Entering and editing.....	1-7	◇ Adjusting the NB level and time.....	4-5
◇ Entering and editing example .....	1-8	Noise Reduction .....	4-6
		◇ Adjusting the Noise Reduction level .....	4-6
<b>2 INSTALLATION AND CONNECTIONS .....</b>	<b>2-1</b>	Notch Filter .....	4-6
Selecting a location .....	2-1	◇ Auto Notch function .....	4-6
Front panel connection.....	2-1	◇ Manual Notch function.....	4-6
Heat dissipation.....	2-1	VOX function .....	4-7
Grounding.....	2-1	◇ Adjusting the VOX function.....	4-7
Rear panel connection .....	2-2	◇ Turning ON the VOX function .....	4-7
Connecting an external DC power supply .....	2-3	$\Delta$ TX function.....	4-8
Connecting the antenna tuner .....	2-3	◇ $\Delta$ TX monitor function .....	4-8
		Monitor function.....	4-8
<b>3 BASIC OPERATION .....</b>	<b>3-1</b>	Setting the Speech Compressor .....	4-9
When first applying power.....	3-1	Split frequency operation.....	4-10
Turning power ON or OFF.....	3-1	◇ Using the Quick Split function.....	4-10
Adjusting the volume level.....	3-1	◇ Using the receive and transmit frequencies set to VFO A and VFO B.....	4-10
About the VFO and Memory modes.....	3-1	Split Lock function .....	4-11
Using the VFO mode.....	3-1	Setting the transmit filter width .....	4-11
◇ Selecting the VFO A or VFO B.....	3-1	Operating CW.....	4-11
◇ Equalizing VFO A and VFO B.....	3-1	◇ Setting the CW pitch control .....	4-11
Selecting the operating band.....	3-2	◇ Setting the key speed .....	4-12
◇ Using the band stacking registers.....	3-2	◇ About the Break-in function .....	4-12
Selecting the operating mode.....	3-2	◇ CW Auto Tuning function .....	4-13
Setting the frequency .....	3-3	◇ About the CW Reverse mode .....	4-13
◇ Using the Main Dial.....	3-3	◇ Electronic Keyer function .....	4-14
◇ About the Tuning Step function.....	3-3	◇ Monitoring the CW side tone .....	4-14
◇ Changing the Tuning Step .....	3-3		
◇ About the 1 Hz step Fine Tuning function..	3-3		
◇ About the 1/4 Tuning function .....	3-4		
◇ About the Auto Tuning Step function .....	3-4		
◇ Directly entering a frequency .....	3-4		
◇ Band Edge Beep.....	3-5		

---

## TABLE OF CONTENTS (Continued)

---

4	RECEIVING AND TRANSMITTING (Continued)	
	Operating RTTY (FSK).....	4-15
	◇ About the RTTY reverse mode .....	4-15
	◇ Twin Peak Filter .....	4-15
	◇ Functions on the RTTY DECODE screen ...	4-16
	◇ Setting the decoder threshold level .....	4-16
	FM repeater operation.....	4-17
	◇ Setting the repeater tone frequency .....	4-17
5	<b>SCOPE OPERATION</b> .....	<b>5-1</b>
	Spectrum scope screen.....	5-1
	◇ Using the Spectrum Scope .....	5-1
	◇ Center mode .....	5-2
	◇ Fixed mode .....	5-2
	◇ Marker.....	5-2
	◇ Touch screen operation .....	5-3
	◇ Mini scope screen.....	5-3
	Audio scope screen.....	5-3
6	<b>USING AN SD CARD</b> .....	<b>6-1</b>
	About the SD card .....	6-1
	Saving data onto the SD card .....	6-1
	Inserting or removing the SD card.....	6-1
	◇ Inserting .....	6-1
	◇ Removing.....	6-1
	Unmounting an SD card .....	6-2
	Formatting an SD card .....	6-2
7	<b>ANTENNA TUNER OPERATION</b> .....	<b>7-1</b>
	About the internal antenna tuner.....	7-1
	Internal antenna tuner operation .....	7-1
	◇ Manual tuning .....	7-1
	◇ PTT Tuner start.....	7-1
8	<b>SET MODE</b> .....	<b>8-1</b>
	Set mode description.....	8-1
	◇ Entering the Set mode .....	8-1
	Tone Control .....	8-2
	Function.....	8-3
	Connectors .....	8-5
	Display.....	8-6
	Time Set .....	8-7
	SD Card.....	8-7
	Others.....	8-7
9	<b>MAINTENANCE</b> .....	<b>9-1</b>
	Resetting .....	9-1
	◇ Partial reset.....	9-1
	◇ All reset.....	9-1
10	<b>SPECIFICATIONS</b> .....	<b>10-1</b>
	◇ General .....	10-1
	◇ Transmitter.....	10-1
	◇ Receiver.....	10-2
	◇ Antenna tuner .....	10-2
11	<b>OPTIONS</b> .....	<b>11-1</b>
	Options.....	11-1
	Mounting the MB-118 .....	11-2
12	<b>CONNECTOR INFORMATION</b> .....	<b>12-1</b>
	ACC socket .....	12-1
	◇ OPC-599 ACC conversion cable pin assignments.....	12-2
	Microphone connector.....	12-2
	◇ External keypad .....	12-2
	KEY jack.....	12-3
	EXT-SP jack .....	12-3
	REMOTE jack.....	12-3
	ALC jack.....	12-3
	SEND jack.....	12-3
	PHONES jack .....	12-3
	DC power socket.....	12-3
	<b>INDEX</b> .....	<b>I</b>
	<b>ABOUT CE</b> .....	<b>III</b>
	<b>INSTALLATION NOTES</b> .....	<b>III</b>

---

## PRECAUTIONS

---

⚠ **DANGER HIGH RF VOLTAGE! NEVER** touch an antenna or antenna connector while transmitting. This could cause an electrical shock or burn.

⚠ **DANGER! NEVER** operate the transceiver near unshielded electrical blasting caps or in an explosive atmosphere. This could cause an explosion and death.

⚠ **WARNING RF EXPOSURE!** This device emits Radio Frequency (RF) energy. Extreme caution should be observed when operating this device. If you have any questions regarding RF exposure and safety standards please refer to the Federal Communications Commission Office of Engineering and Technology's report on Evaluating Compliance with FCC Guidelines for Human Radio Frequency Electromagnetic Fields (OET Bulletin 65).

⚠ **WARNING! NEVER** operate the transceiver with a headset or other audio accessories at high volume levels. If you experience a ringing in your ears, reduce the volume or discontinue use.

⚠ **WARNING! NEVER** apply AC power to the [DC13.8V] socket on the transceiver rear panel. This could cause a fire or damage the transceiver.

⚠ **WARNING! NEVER** apply more than 16 V DC to the [DC13.8V] socket on the transceiver rear panel. This could cause a fire or damage the transceiver.

⚠ **WARNING! NEVER** reverse the DC power cable polarity. This could cause a fire or damage the transceiver.

⚠ **WARNING! NEVER** remove the fuse holder on the DC power cable. Excessive current caused by a short could cause a fire or damage the transceiver.

⚠ **WARNING! NEVER** let metal, wire or other objects contact the inside of the transceiver, or make incorrect contact with connectors on the rear panel. This could cause an electric shock or damage the transceiver.

⚠ **WARNING! NEVER** operate or touch the transceiver with wet hands. This could cause an electric shock or damage to the transceiver.

⚠ **WARNING!** Immediately turn OFF the transceiver power and remove the DC power cable from the transceiver if it emits an abnormal odor, sound or smoke. Contact your Icom dealer or distributor for advice.

⚠ **WARNING! NEVER** put the transceiver on an unstable place where the transceiver may suddenly move or fall. This could cause an injury or damage the transceiver.

⚠ **WARNING! NEVER** operate the transceiver during a lightning storm. It may result in an electric shock, cause a fire or damage the transceiver. Always disconnect the power source and antenna before a storm.

**CAUTION: NEVER** expose the transceiver to rain, snow or any liquids.

**CAUTION: NEVER** change the internal settings of the transceiver. This could reduce transceiver performance and/or damage to the transceiver. The transceiver warranty does not cover any problems caused by unauthorized internal adjustments.

**CAUTION: NEVER** install or place the transceiver in a place without adequate ventilation, or block any cooling vents on the top, rear, sides or bottom of the transceiver. Heat dissipation may be reduced and damage the transceiver.

**CAUTION: NEVER** use harsh solvents such as Benzine or alcohol when cleaning, as they will damage the transceiver surfaces.

**CAUTION: NEVER** leave the transceiver in areas with temperatures below  $-10^{\circ}\text{C}$  ( $+14^{\circ}\text{F}$ ) or above  $+60^{\circ}\text{C}$  ( $+140^{\circ}\text{F}$ ) for mobile operations.

**CAUTION: NEVER** place the transceiver in excessively dusty environments. This could damage the transceiver.

**DO NOT** place the transceiver against walls or putting anything on top of the transceiver. This may overheat the transceiver.

**BE CAREFUL!** The Main unit will become hot when operating the transceiver continuously for long periods of time.

**CAUTION:** If you use a linear amplifier, set the transceiver's RF output power to less than the linear amplifier's maximum input level, otherwise a high input could damage the linear amplifier.

**CAUTION:** Use only Icom supplied or optional microphones. Other manufacturer's microphones may have different pin assignments, and could damage the connector and/or the transceiver.

**NEVER** leave the transceiver in an insecure place to avoid use by unauthorized persons.

Turn OFF the transceiver's power and/or disconnect the AC power cable when you will not use the transceiver for a long period of time.

Turn OFF the transceiver's power and/or disconnect the DC power cable when you will not use the transceiver for long period of time.

The LCD display may have cosmetic imperfections that appear as small dark or light spots. This is not a malfunction or defect, but a normal characteristic of LCD displays.

## Front panel

This section describes the keys, controls and dials that you use to operate the IC-7300. Refer to the pages posted beside each key, control, or dial for details.

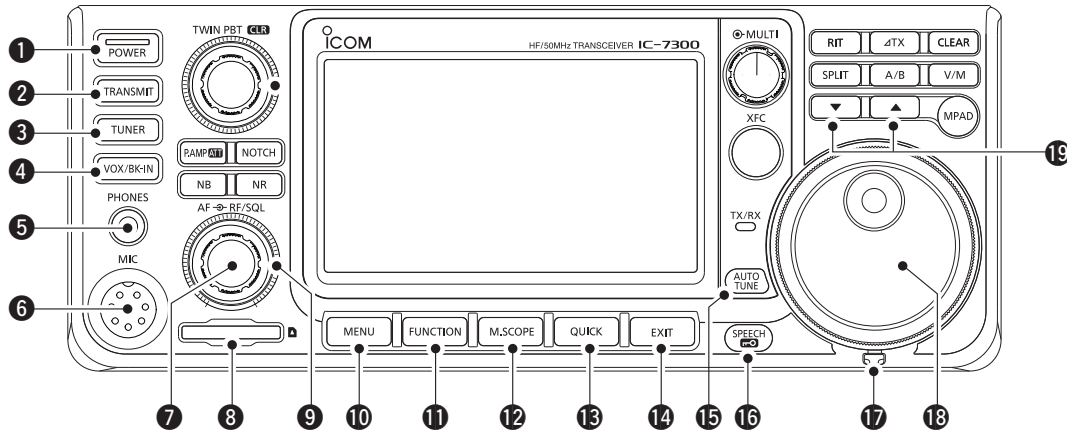

- 1 POWER KEY** **POWER** (p. 3-1)  
Turns the transceiver ON or OFF.
- 2 TRANSMIT KEY** **TRANSMIT** (p. 3-9)  
Toggles between transmit and receive.
- 3 ANTENNA TUNER KEY** **TUNER** (p. 7-1)  
Turns the antenna tuner ON or OFF, or activates the tuner.
- 4 VOX/BREAK-IN KEY** **VOX/BK-IN**  
Turns the VOX function (p. 4-7) and Break-in function (p. 4-12) ON or OFF.
- 5 HEADPHONE JACK** **[PHONES]** (p. 2-1)  
Connects to a standard stereo headphones.
- 6 MICROPHONE CONNECTOR** **[MIC]** (p. 2-1)  
Connects to the supplied or an optional microphone.
- 7 VOLUME CONTROL** **AF-RF/SQL** (p. 3-1)  
Adjusts the audio output level.
- 8 SD CARD SLOT** **[SD CARD]** (p. 6-1)  
Accepts an SD card.
- 9 RF GAIN CONTROL/SQUELCH CONTROL** **AF-RF/SQL** (p. 3-9)  
Adjusts the RF gain and squelch threshold levels.
- 10 MENU KEY** **MENU** (p. 1-6)  
Opens the MENU screen.
- 11 FUNCTION KEY** **FUNCTION** (p. 1-6)  
Displays the FUNCTION screen.
- 12 MINI SCOPE KEY** **M.SCOPE** (p. 5-1)  
Displays the Mini Scope or Spectrum Scope.
- 13 QUICK KEY** **QUICK** (p. 1-6)  
Displays the QUICK MENU.
- 14 EXIT KEY** **EXIT** (p. 1-6)  
Exits a setting screen or returns to the previous screen.
- 15 AUTO TUNE KEY** **AUTO TUNE** (p. 4-13)  
Automatically tunes the operating frequency to a received CW signal.
- 16 SPEECH/LOCK KEY** **SPEECH** (p. 3-9)  
Announces the operating frequency or receiving mode, or electronically locks **MAIN DIAL**.
- 17 TENSION ADJUSTER**  
Adjusts the friction of **MAIN DIAL**.
- 18 MAIN DIAL** **MAIN DIAL** (p. 3-3)  
Changes the operating frequency.
- 19 MEMORY CHANNEL UP/DOWN KEY** **▲/▼**  
Changes the Memory channel.

# 1 PANEL DESCRIPTION

## Front panel (Continued)

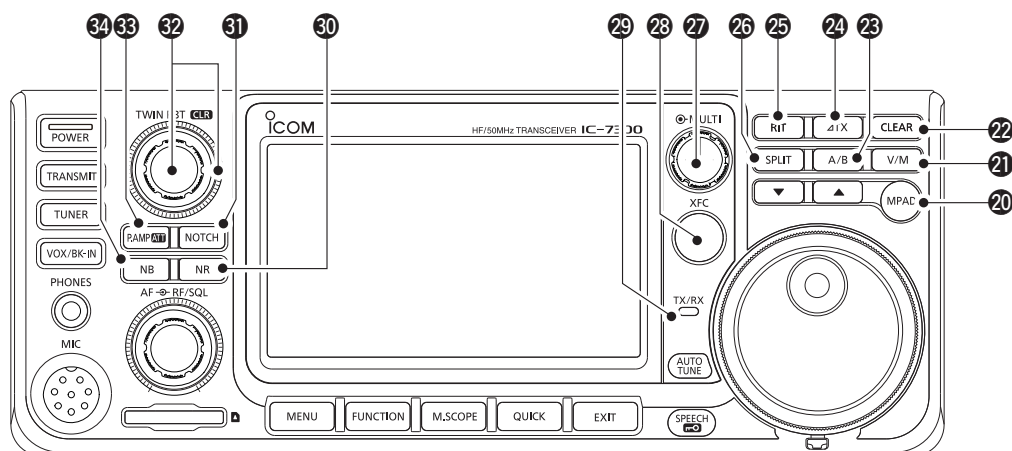

- 20 MEMO PAD KEY MPAD**  
Sequentially calls up the contents in the Memo Pads, or saves the displayed contents into the Memo Pad.
- 21 VFO/MEMORY KEY V/M (p. 3-1)**  
Switches between the VFO and Memory mode, or copies the memory channel contents to the VFO.
- 22 CLEAR KEY CLEAR**  
Clears the RIT or ΔTX shift frequency.
- 23 A/B KEY A/B (p. 3-1)**  
Switches between VFO A and VFO B, or sets the selected VFO's frequency to the other VFO.
- 24 ΔTX KEY ΔTX (p. 4-8)**  
Turns the ΔTX function ON or OFF.
- 25 RIT KEY RIT (p. 4-1)**  
Turns the Receiver Incremental Tuning (RIT) function ON or OFF.
- 26 SPLIT KEY SPLIT (p. 4-10)**  
Turns the Split function ON or OFF.
- 27 MULTI-FUNCTION CONTROL MULTI (p. 1-6)**  
Displays the Multi-function menu for various adjustments, or selects a desired item.
- 28 TRANSMIT FREQUENCY CHECK KEY XFC (p. 4-8)**  
Enables you to monitor the transmit frequency while holding it down in the Split mode.
- 29 TX/RX INDICATOR (p. 3-9)**  
Lights red while transmitting and lights green while receiving.
- 30 NOISE REDUCTION KEY NR (p. 4-6)**  
Turns the Noise Reduction function ON or OFF.
- 31 NOTCH KEY NOTCH (p. 4-6)**  
Turns the Notch filter ON or OFF.
- 32 TWIN PASSBAND TUNING CONTROL TWIN PBT CLR (p. 4-3)**  
Adjusts the IF filter's passband width.
- 33 PREAMP/ATTENUATOR KEY P.AMPATT (p. 4-1)**  
Turns ON or OFF, and selects one of two receive RF preamplifiers or turns the Attenuator ON or OFF.
- 34 NOISE BLANKER KEY NB (p. 4-5)**  
Turns the Noise Blanker ON or OFF.



## Rear panel

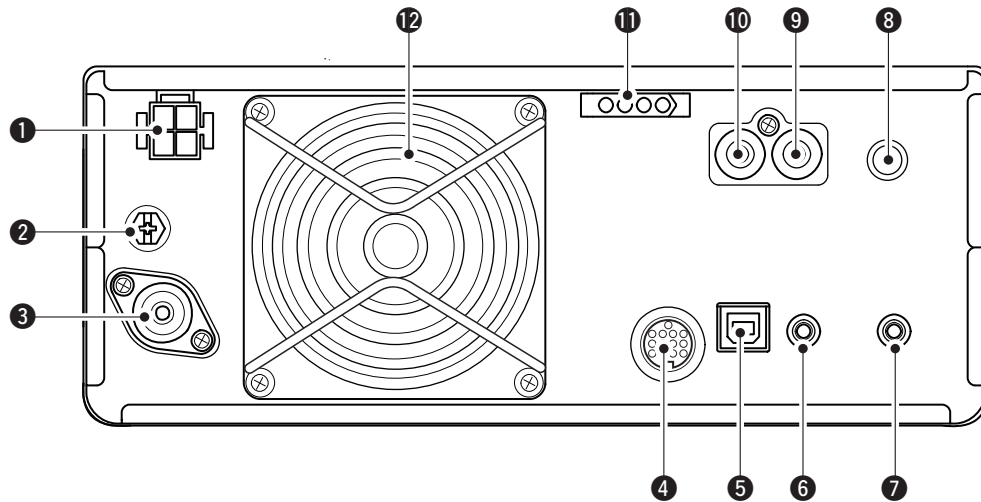

### ❶ DC POWER SOCKET [DC 13.8 V] (p. 2-2)

Accepts 13.8 V DC through the DC power cable.

### ❷ GROUND TERMINAL [GND] (p. 2-1)

Connects to ground to prevent electrical shocks, TVI, BCI and other problems.

### ❸ ANTENNA CONNECTOR [ANT] (p. 2-2)

Connects to a 50  $\Omega$  PL-259 coax connector.

### ❹ SOCKET [ACC] (p. 2-2)

Connects to devices to control an external unit or to control the transceiver.

### ❺ USB PORT (B TYPE) [USB] (p. 2-2)

Connects to a PC.

### ❻ CI-V REMOTE CONTROL JACK [REMOTE] (p. 2-2)

- Connects to a PC or other transceiver for external control.

### ❼ EXTERNAL SPEAKER JACK [EXT-SP] (p. 2-2)

Accepts a 4~8  $\Omega$  external speaker.

### ❽ KEY JACK [KEY] (p. 2-2)

Connects to a straight key, external electronic keyer, or a paddle with 6.35 mm (1/4") stereo plug.

### ❾ SEND CONTROL JACK [SEND] (p. 2-2)

Connects to control transmit with non-Icom external units.

### ❿ ALC INPUT JACK [ALC] (p. 2-2)

Connects to the ALC output jack of a non-Icom linear amplifier.

### ⓫ TUNER CONTROL SOCKET [TUNER] (p. 2-2)

Accepts the control cable from an optional AH-4 or AH-740 AUTOMATIC ANTENNA TUNER.

### ⓬ COOLING FAN

Cools the PA unit when necessary.

## Touch panel display

This section describes the icons, screens, dialogs, readouts and so on that are displayed on the IC-7300 screen. Refer to the pages posted beside each item for details.

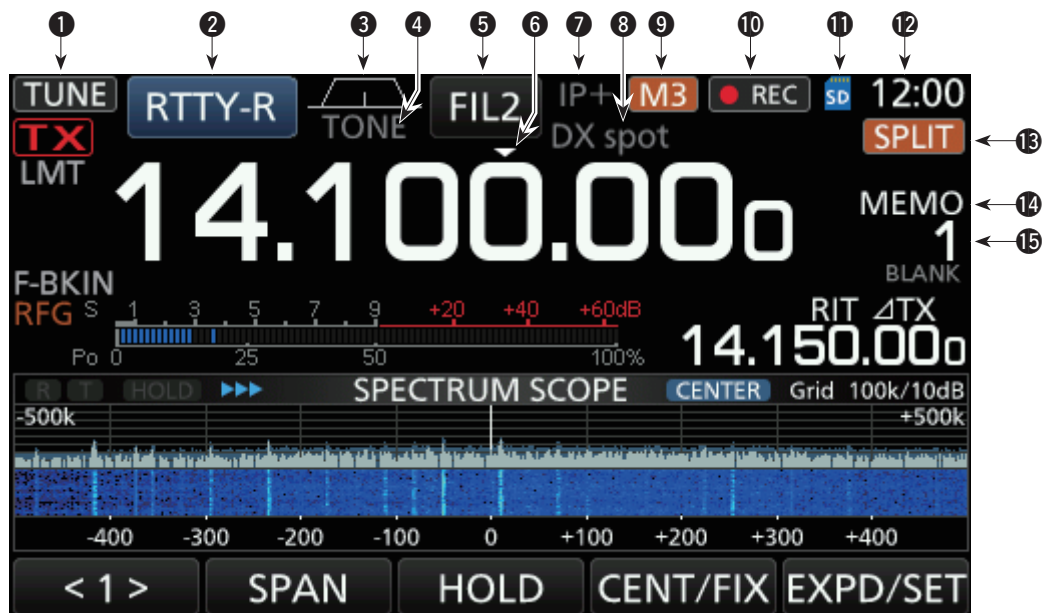

- 1 TUNE ICON** TUNE (p. 7-1)  
Appears while tuning the antenna.
- 2 MODE INDICATOR** RTTY-R (p. 3-2)  
Displays the selected operating mode.
- 3 PASSBAND WIDTH INDICATOR** ▬▬▬  
(p. 4-3)  
Graphically displays the passband width for twin PBT operation and the center frequency for IF shift operation.
- 4 TONE INDICATOR** TONE (p. 4-17)  
Displays the selected tone type in the tone operation mode.
- 5 IF FILTER INDICATOR** FIL2 (p. 4-4)  
Displays the selected IF filter.
- 6 QUICK TUNING ICON** ▾  
Appears when the Quick Tuning Step function is ON.
- 7 IP PLUS ICON** (p. 4-5)  
Appears when the IP Plus function is ON.
- 8 MEMORY NAME READOUT** (p. 1-8)  
Displays the memory name if entered.
- 9 M1~M8/T1~T8/OVF ICON** M3  
Displays “M1”~“M8” while “External Keypad” on the CONNECTORS screen is set to ON and using the Memory Keyer function (p. 4-14). Displays “T1”~“T8” while using the Voice TX memory. Displays “OVF” when an excessively strong signal is received.
- 10 VOICE RECORDER ICON** ● REC  
Appears while recording.
- 11 SD CARD ICON** SD (p. 6-1)  
Appears when an SD card is inserted, or blinks while accessing the SD card.
- 12 CLOCK READOUT** 23:00  
Displays the current local time.  
Touch the readout to display both the current local time and UTC time.
- 13 SPLIT ICON** SPLIT (p. 4-10)  
Appears when the Split function is ON.
- 14 VFO/MEMORY ICON** MEMO (p. 3-1)  
“VFO A” or “VFO B” appears when the VFO mode is selected, and “MEMO” appears when the Memory mode is selected.
- 15 MEMORY CHANNEL READOUT** 1  
Displays the selected memory channel number.

Touch panel (Continued)

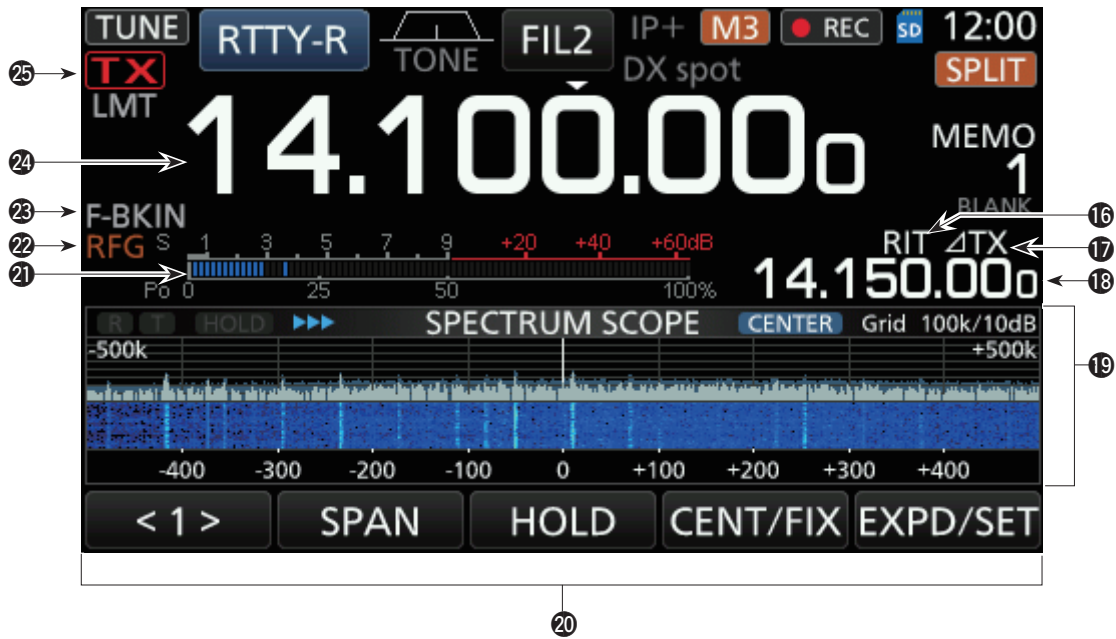

- 16 RIT ICON **RIT** (p. 4-1)  
Appears while the RIT function is ON.
- 17  $\Delta$ TX ICON  **$\Delta$ TX** (p. 4-8)  
Appears while the  $\Delta$ TX function is ON.
- 18 SHIFT FREQUENCY READOUT  
Displays the shift frequency of the RIT (p. 4-1) or  $\Delta$ TX (p. 4-8) functions, while the functions are ON.
- 19 SPECTRUM SCOPE SCREEN (p. 5-1)  
Displayed while using the Spectrum Scope.
- 20 FUNCTION DISPLAY  
Displays the operating parameters, modes, frequencies and indicators, depending on your selections.
- 21 MULTI-FUNCTION METER (p. 3-10)  
Displays various strengths and levels, depending on the function you select.
- 22 RF GAIN ICON **RFG** (p. 3-9)  
Appears when (AF $\odot$ RF/SQL) (outer) is set to the counterclockwise from the 11 o'clock position. The icon indicates that the RF gain is reduced.
- 23 BK-IN/F-BKIN/VOX INDICATOR **F-BKIN** (p. 4-12)  
Appears while the Semi Break-in, Full Break-in or VOX function is ON.
- 24 FREQUENCY READOUT (p. 3-3)  
Displays the operating frequency.
- 25 TX STATUS INDICATOR **TX** (p. 3-9)  
Displays the transmit status of the displayed frequency.
  - **TX** appears while transmitting.
  - **TX** appears when the selected frequency is outside of the amateur band frequency range.
  - **TX** appears while transmitter is inhibited (p. 3-10)

# 1 PANEL DESCRIPTION

## Touch panel (Continued)

### ◇ Multi-function menus

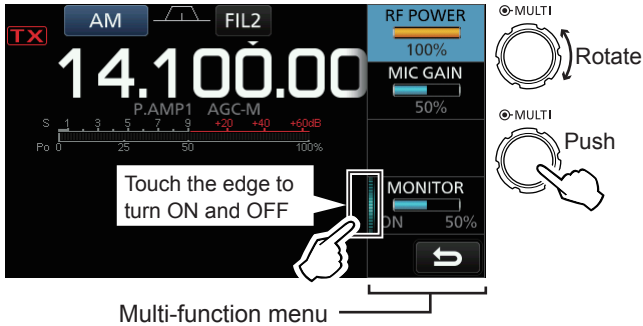

Multi-function menu

- Open the Multi-function menu by pushing **(MULTI)** (Multi-function control).
- Open different types of menus by holding down **(VOX/BK-IN)**, **(NB)**, **(NR)**, or **(NOTCH)** for 1 second.
- While the Multi-function menu is opened, touch the desired item and rotate **(MULTI)** to set the desired value.

### Multi-function menu items

\*Touch the edge to turn the function ON or OFF, or adjust.

SSB	SSB-D	CW	RTTY
RF POWER	RF POWER	RF POWER	RF POWER
MIC GAIN	MIC GAIN	KEY SPEED	TPF*
COMP*		CW PITCH	
MONITOR*	MONITOR*		MONITOR*
FM	AM	NB	NR
RF POWER	RF POWER	LEVEL	LEVEL
MIC GAIN	MIC GAIN	DEPTH	
		WIDTH	
MONITOR*	MONITOR*		
NOTCH	VOX	BK-IN	
POSITION	GAIN	DELAY	
WIDTH*	ANTI VOX		
	DELAY		
	VOICE DELAY		
	SHORT*		

### ◇ MENU screen



- Open the MENU screen by pushing **(MENU)**.

### ◇ FUNCTION screen

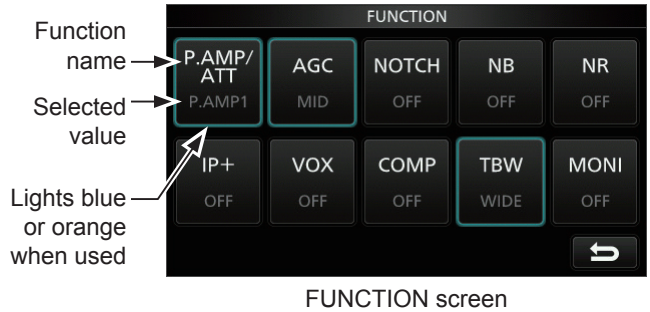

FUNCTION screen

- Open the FUNCTION screen by pushing **(FUNCTION)**.  
① To close the FUNCTION screen, push **(EXIT)**.

### FUNCTION screen list

\*1 Touch for 1 second to select the function.

\*2 Touch for 1 second to open its function menu.

P.AMP/ATT	AGC* <sup>2</sup>	NOTCH* <sup>2</sup>	NB* <sup>2</sup>
OFF	FAST	OFF	OFF
P.AMP1	MID	AN	ON
P.AMP2	SLOW	MN	
ATT* <sup>1</sup>			
NR* <sup>2</sup>	IP+	VOX* <sup>2</sup>	BKIN* <sup>2</sup>
OFF	OFF	OFF	OFF
ON	ON	ON	BKIN
			F-BKIN
COMP* <sup>2</sup>	TONE* <sup>2</sup>	TBW	1/4
OFF	OFF	WIDE	OFF
ON	TONE	MID	ON
	TSQL	NAR	
MONI* <sup>2</sup>			
OFF			
ON			

### ◇ QUICK MENU

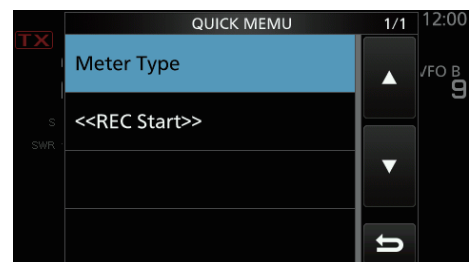

- Open the QUICK MENU by pushing **(QUICK)**.

# Keyboard entering and editing

## ◇ Entering and editing characters

You can enter and edit the items in the following table.

Category	Screen	Selectable characters	Total characters	Information
MENU	MY CALL	A to Z, 0 to 9, (space), / @ - .	10	
MEMORY	MEMORY NAME	A to Z, a to z, 0 to 9, (space), @ % & # + - = [ ] / ( ) ; : ^ ! ? . ,	10	
FUNCTION	KEYER MEMORY	A to Z, 0 to 9, (space), / ? ^ . , @	70	“*” (asterisk) has its unique use.
	RTTY MEMORY	A to Z, 0 to 9, (space), ! \$ & ? " ' - / . , ; ( ) _ \	70	
	VOICE TX RECORD	A to Z, a to z, 0 to 9, (space), _ ! " # \$ % & ' ( ) * + , - . / ; : < = > ? @ [ \ ] ^ _ ` {   } ~	16	
SD Card	FILE NAME	A to Z, a to z, 0 to 9, (space), _ ! " # \$ % & ' ( ) * + , - . / ; : < = > ? @ [ \ ] ^ _ ` {   } ~	15	<i>Illegal characters:</i> / ; * < >

## ◇ Keyboard types

You can select the Full Keyboard or Tenkey in “Keyboard Type” on the FUNCTION screen. (p. 8-4)

**MENU** » **SET > Function > Keyboard Type**

① You can also temporarily switch in the QUICK MENU by pushing **QUICK**.

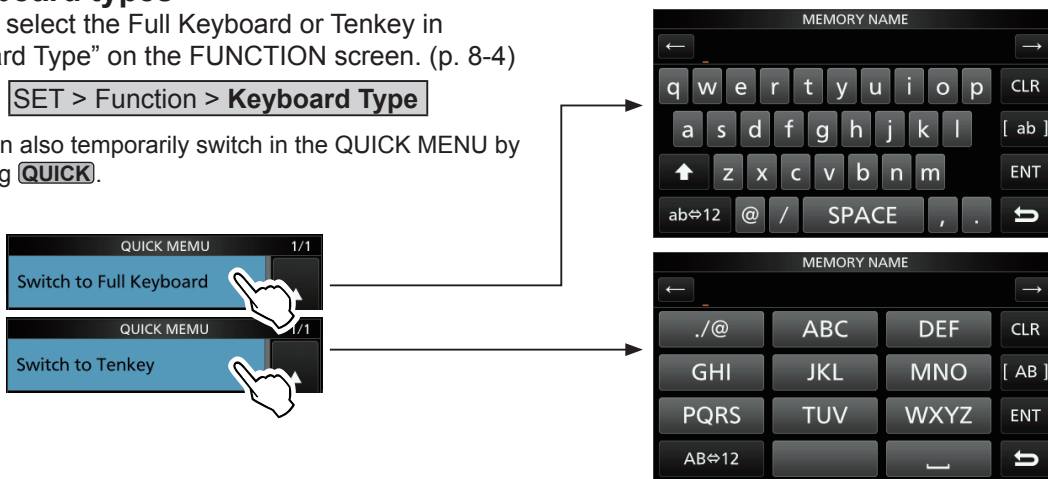

## ◇ Entering and editing

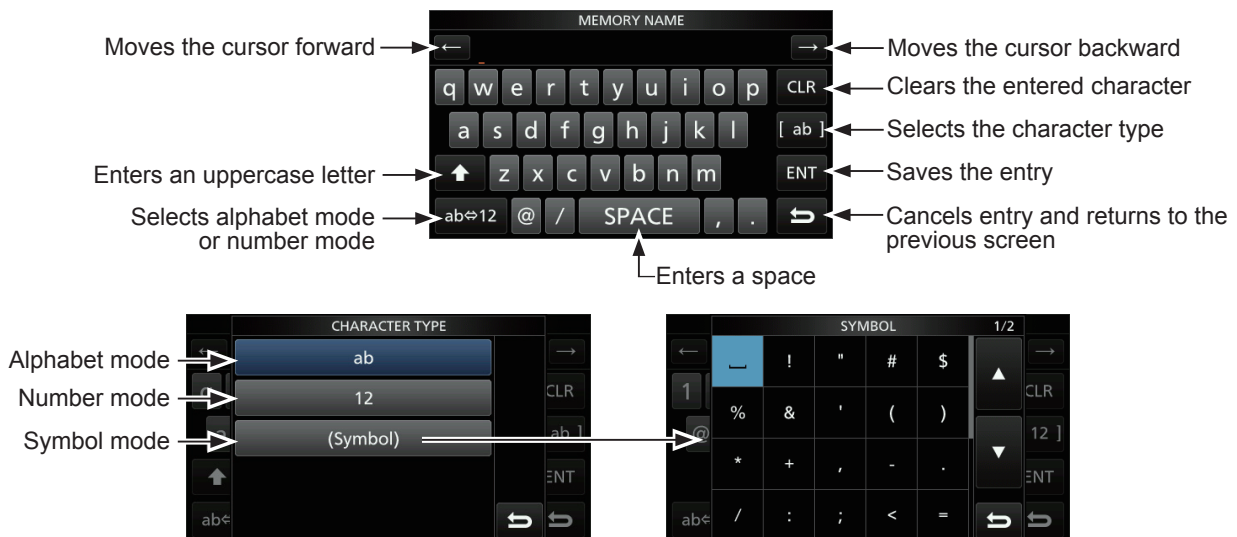

# 1 PANEL DESCRIPTION

## Keypad entering and editing (Continued)

### ◇ Entering and editing example

Entering “DX spot 1” in the Memory channel 2

1. Open the MEMORY screen.



2. Touch the memory channel 2 for 1 second.

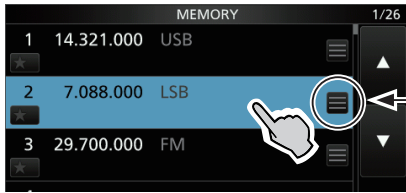

You can also open the QUICK MENU by touching this key.

- Opens the QUICK MENU.

3. Select “Edit Name.”

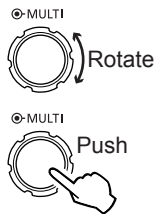
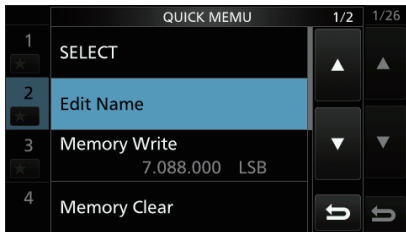

- Opens the MEMORY NAME screen.

4. Touch [↑], and then touch [D].



5. Touch [↑] again, and then touch [X].
6. Touch [SPACE].

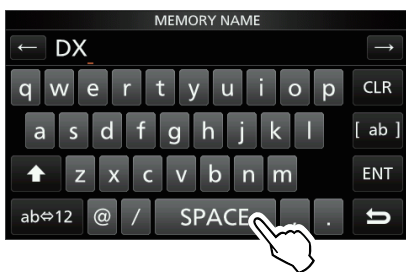

- Enters a space.

7. Touch [s], [p], [o], and then [t].
  8. Touch [SPACE].
- Enters a space.

9. Touch [ab].

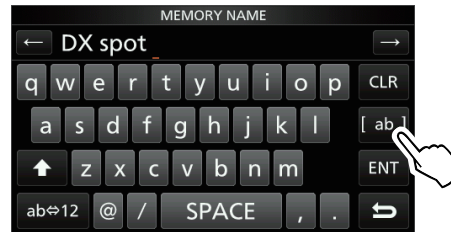

- Opens the entry CHARACTER TYPE screen.

10. Touch [12].

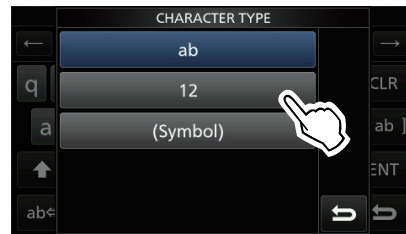

11. Touch [1].
12. Touch [ENT] to save the entry.

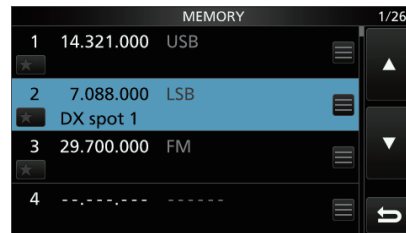

- Returns to the previous screen.



## Selecting a location

Select a location for the transceiver that allows adequate air circulation, free from extreme heat, cold or vibrations, and other electromagnetic sources.

The transceiver has a stand for desktop use.

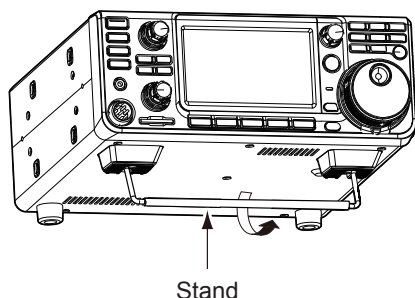

**CAUTION: NEVER** carry the transceiver by holding the stand, dials, controls and so on. This may damage them.

## Heat dissipation

- **DO NOT** place the transceiver against walls or put anything on top of the transceiver. This may block airflow and overheat the transceiver.
- **NEVER** install the transceiver in a place without adequate ventilation. Heat dissipation may be reduced, and the transceiver may be damaged.
- **DO NOT** touch the transceiver after transmitting continuously for long periods of time. The transceiver may become hot.

## Grounding

To prevent electrical shock, television interference (TVI), broadcast interference (BCI) and other problems, ground the transceiver using the ground terminal [GND] on the rear panel.

For best results, connect a heavy gauge wire or strap to a long ground rod. Make the distance between the [GND] terminal and ground as short as possible.

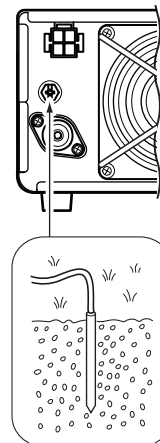

**⚠ WARNING! NEVER** connect the [GND] terminal to a gas or electric pipe, since the connection could cause an explosion or electric shock.

## Front panel connection

### [MIC] (Microphone) connector



### Using an External Keypad

You can control the CW memory keyer, Voice memory or RTTY memory keyer transmission from an external keypad by connecting the control circuit to the [MIC] connector. Set the "External Keypad" to ON on the CONNECTORS screen to use the external keypad. (p. 8-5)

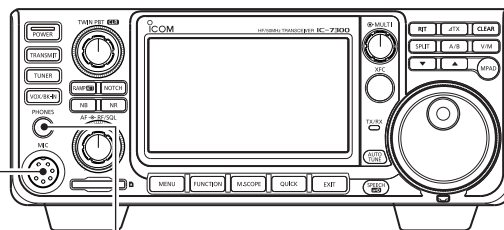

### [PHONES] Headphones



Accepts headphones with 8~16  $\Omega$  impedance.

- Outputs 5 mW into an 8  $\Omega$  load.
- The volume level may differ, depending on the headphones.

# Rear panel connection

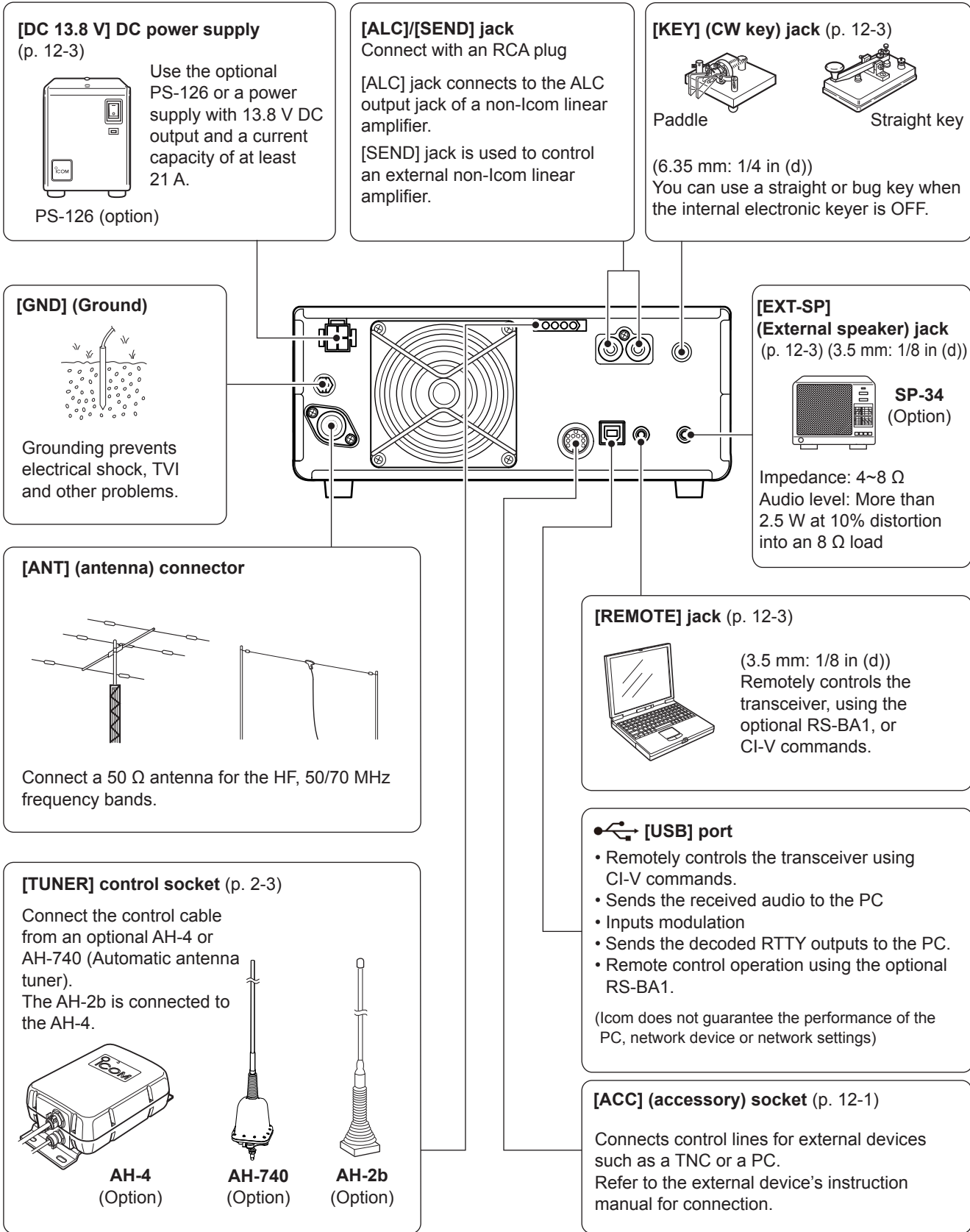

**[DC 13.8 V] DC power supply**  
(p. 12-3)



PS-126 (option)

Use the optional PS-126 or a power supply with 13.8 V DC output and a current capacity of at least 21 A.

**[ALC]/[SEND] jack**  
Connect with an RCA plug

[ALC] jack connects to the ALC output jack of a non-Icom linear amplifier.

[SEND] jack is used to control an external non-Icom linear amplifier.

**[KEY] (CW key) jack** (p. 12-3)

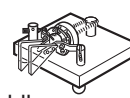

Paddle

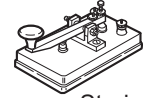

Straight key

(6.35 mm: 1/4 in (d))  
You can use a straight or bug key when the internal electronic keyer is OFF.

**[GND] (Ground)**

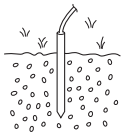

Grounding prevents electrical shock, TVI and other problems.

**[ANT] (antenna) connector**

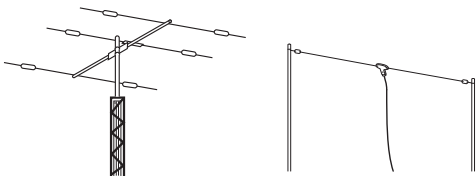

Connect a 50 Ω antenna for the HF, 50/70 MHz frequency bands.

**[TUNER] control socket** (p. 2-3)

Connect the control cable from an optional AH-4 or AH-740 (Automatic antenna tuner).

The AH-2b is connected to the AH-4.

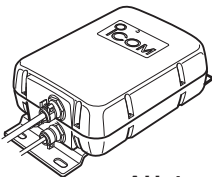

AH-4  
(Option)



AH-740  
(Option)

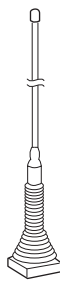

AH-2b  
(Option)

**[EXT-SP] (External speaker) jack**  
(p. 12-3) (3.5 mm: 1/8 in (d))

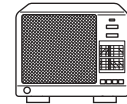

SP-34  
(Option)

Impedance: 4~8 Ω  
Audio level: More than 2.5 W at 10% distortion into an 8 Ω load

**[REMOTE] jack** (p. 12-3)



(3.5 mm: 1/8 in (d))  
Remotely controls the transceiver, using the optional RS-BA1, or CI-V commands.

**[USB] port**

- Remotely controls the transceiver using CI-V commands.
- Sends the received audio to the PC
- Inputs modulation
- Sends the decoded RTTY outputs to the PC.
- Remote control operation using the optional RS-BA1.

(Icom does not guarantee the performance of the PC, network device or network settings)

**[ACC] (accessory) socket** (p. 12-1)

Connects control lines for external devices such as a TNC or a PC.  
Refer to the external device's instruction manual for connection.

## Connecting an external DC power supply

Confirm that the transceiver is OFF before connecting the DC power cable.

- ① We recommend using Icom's optional PS-126 (DC 13.8 V/25 A) power supply.
- ① When connecting a non-Icom DC power cable, the transceiver needs:
  - DC 13.8 V (Capacity: At least 21 Amps)
  - a power supply with an over current protective line and low voltage fluctuation or ripple.

**CAUTION: DO NOT** touch the cooling fan on the rear panel of the transceiver after transmitting continuously for long periods of time. The transceiver becomes extremely hot.

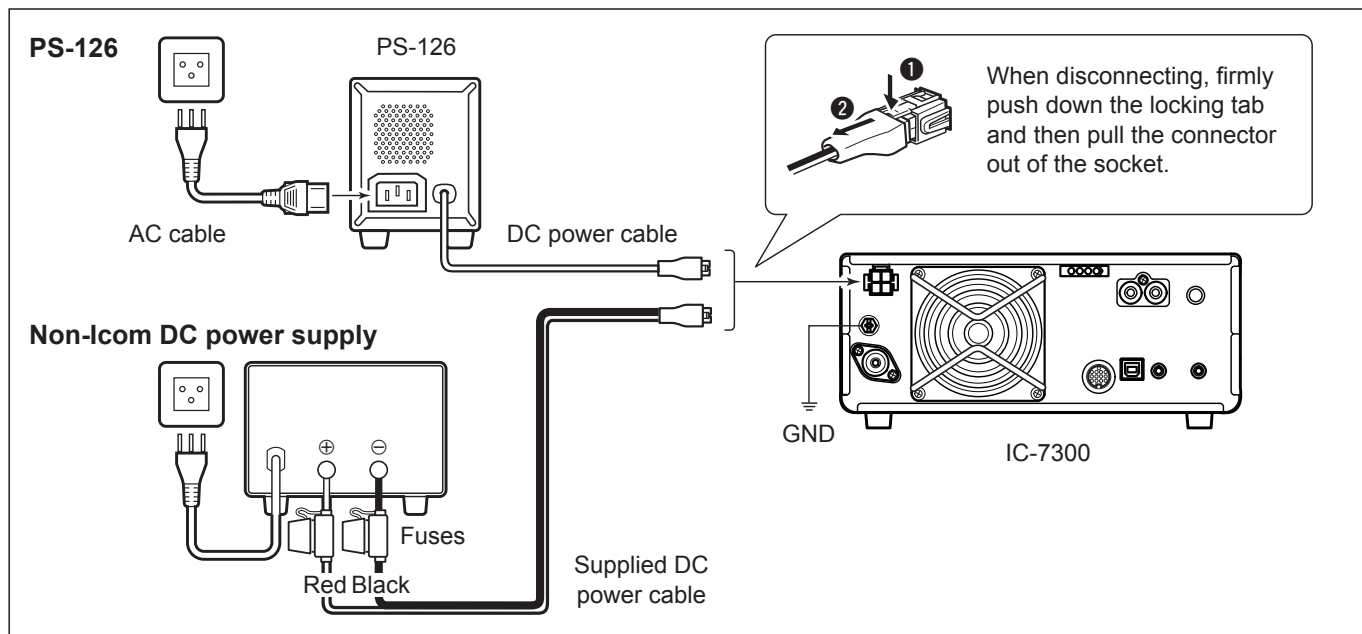

## Connecting the antenna tuner

The AH-4 AUTOMATIC ANTENNA TUNER matches the IC-7300 to the optional AH-2b or a long wire antenna more than 7 m/23 ft long (between 3.5 MHz and 50 MHz).

- ① See the AH-4 instruction manual for installation and connection details.

**NOTE:** Before connecting, be sure to turn OFF the transceiver power.

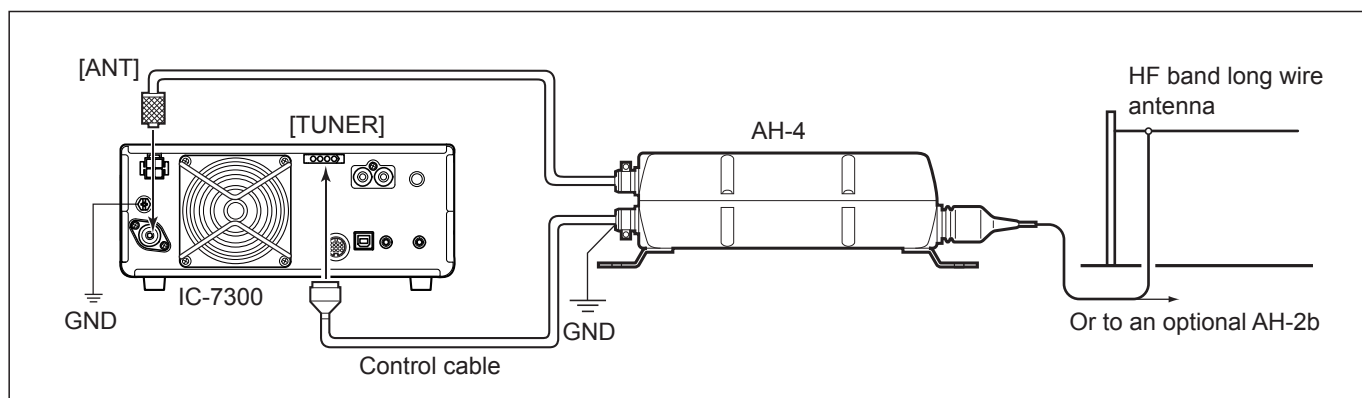

## When first applying power

Before turning ON your transceiver for the first time, make sure all of the following are correctly connected.

- DC power cable
- Antenna
- Grounding wire
- Microphone\*

\*Different device may be used, depending on the operating mode.

If all listed above are correctly connected, set **AF↔RF/SQL** (inner/outer) to the positions described below.

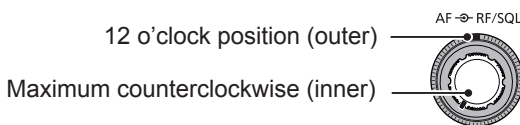

**TIP:** When you turn OFF the transceiver, it memorizes the current settings. Therefore, when you turn ON the transceiver again, it restarts with the same settings.

## Turning power ON or OFF

- To turn ON the transceiver, push **POWER**.
- To turn OFF the transceiver, hold down **POWER** for 2 seconds until "POWER OFF..." is displayed.

## Adjusting the volume level

Rotate **AF↔RF/SQL** (inner) to adjust the volume level.

## About the VFO and Memory modes

### VFO mode

You can set the desired frequency by rotating **MAIN DIAL**.

### Memory mode

You can enter contents into the desired channel in the MEMORY list.

### Selecting the VFO mode or Memory mode

Push **V/M** to select the VFO or Memory mode.

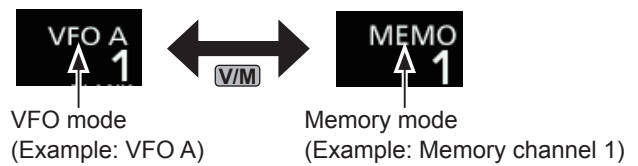

## Using the VFO mode

The IC-7300 has 2 Variable Frequency Oscillators (VFO), "A" and "B." Having 2 VFOs is convenient to quickly select 2 frequencies, or for split frequency operation (p. 4-10). You can use either of the VFOs to operate on a frequency and mode.

### ◇ Selecting the VFO A or VFO B

Push **A/B** to select the VFO A or VFO B.

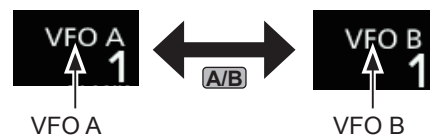

### ◇ Equalizing VFO A and VFO B

You can set the displayed VFO's frequency to the VFO that is not displayed.

Hold down **A/B** until 2 short beeps sound.

## Selecting the operating band

Do the following steps to change the operating band. Also, the band stacking register provides 3 memories for each band key to store frequencies and operating modes. This function is convenient for a quick setting of the previously operated frequency and mode on one frequency band.

### ◇ Using the band stacking registers

Follow the steps below to memorize the selected band. (Example: Memorizing 21 MHz)

1. Touch the MHz digits. (Example: 14)



- Opens the BAND STACKING REGISTER screen.

2. Touch the band key. (Example: [21])

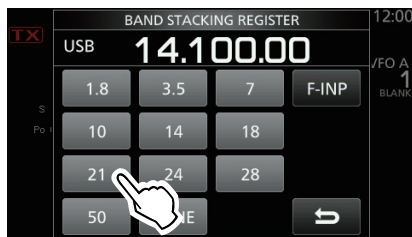

BAND STACKING REGISTER screen

- Displays a 21 MHz frequency.

#### TIP: Selecting a different Register

- ① Touching the band key for 1 second changes between 3 Registers.
- ① Touch to return to the previous screen.

3. Set the frequency and the operating mode. (Example: 21.30000 MHz in the USB mode)



4. Touch the MHz digits again.
  - ① The frequency and operating mode set in step 3 is memorized in the selected Register.
5. By repeating the steps above, the Register that a new frequency and operating mode are set in is memorized in 3 Registers.

## Selecting the operating mode

You can select between the SSB, SSB data, CW, CW reverse, RTTY, RTTY reverse, AM, AM data, FM and FM data modes.

1. Touch the mode icon (example: USB).



2. In the MODE screen, touch the desired mode key. (Example: CW).

- ① In the SSB, AM or FM modes, the [DATA] key is displayed.



MODE screen

#### • Operating mode selection list

- ① Touch mode key to select the operating mode

Mode key	Operating mode	
[SSB]	LSB	USB
[CW]	CW	CW-R
[RTTY]	RTTY	RTTY-R
[AM]	AM	
[FM]	FM	
[DATA]	LSB	LSB-D
	USB	USB-D
	AM	AM-D
	FM	FM-D

## Selecting the Data mode

You can operate the data mode using AFSK (Audio Frequency Shift Keying).

- ① When a data mode is selected, you can mute the input from the microphone. (p. 3-2)

**MENU** » **SET > Connectors > DATA MOD**

(Example: selecting the USB-D mode)

1. While the USB mode is selected, touch the mode icon.
  - Opens the MODE screen.
2. Touch [DATA].



MODE screen

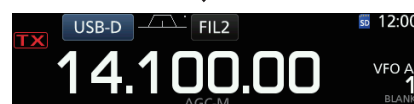

- The USB-D mode is selected.

## Setting the frequency

### ◇ Using the Main Dial

1. Select the desired operating band.  
(Example: 21 MHz)



BAND STACKING REGISTER screen

2. Rotate **(MAIN DIAL)**.

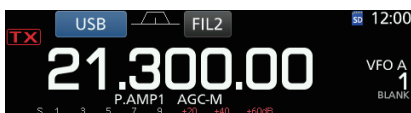

- ① If you cannot change the frequency, make sure the Dial Lock function is turned OFF. (p. 3-9)
- ① **TX** is displayed when you set an amateur radio frequency, and **TX** is displayed when you set a frequency outside the Ham band.

### ◇ About the Tuning Step function

You can set the **(MAIN DIAL)**'s tuning step for each operating mode. The following steps are set as default.

- SSB/CW/RTTY (TS OFF): 10 Hz
- AM (TS ON): 1 kHz
- FM (TS ON): 10 kHz

Touch the kHz digits to turn the Tuning Step function ON or OFF.

- ① The Tuning Step function's icon "▼" is displayed above the 1 kHz digit.

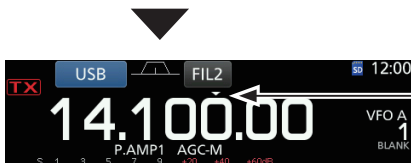

The Tuning Step function is ON.

### ◇ Changing the Tuning Step

When the Tuning Step function is ON, you can change the tuning steps for each operating mode.

1. Select the desired operating mode. (p. 3-2)  
(Example: USB)
2. Touch the kHz digit for 1 second.  
• The TS (SSB) screen is displayed.



3. Touch the desired tuning step.  
(Example: 0.1 k)  
• The tuning step is set and returns to the previous screen.



TS (SSB) screen

The Tuning Step function is ON.

### ◇ About the 1 Hz step Fine Tuning function

You can use the minimum tuning step of 1 Hz for fine tuning in the SSB, CW and RTTY modes.

Touch the Hz digits for 1 second to turn the Fine Tuning function ON or OFF.

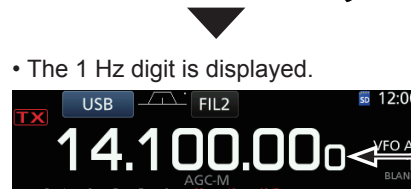

- The 1 Hz digit is displayed.

1Hz digit

- ① When using the [UP]/[DN] keys on the microphone, the frequency changes in 50 Hz step with the Fine Tuning function ON or OFF.



Setting the frequency (Continued)

◇ About the 1/4 Tuning function

Mode: SSB-D/CW/RTTY

With the Tuning Function OFF, turn ON the 1/4 Tuning function to reduce the tuning speed to 1/4 of the normal speed, for finer tuning.

1. Push **FUNCTION**.
  - Opens the FUNCTION screen.
2. Touch [1/4].



FUNCTION screen

3. Push **EXIT**.



1/4 Tuning function

◇ About the Auto Tuning Step function

The tuning step automatically changes, depending on the rotating speed of **MAIN DIAL**.

① You can change the Auto Tuning Step function settings in the following menu. (p. 8-4)

**MENU** » SET > Function > MAIN DIAL Auto TS

◇ Directly entering a frequency

Entering the operating frequency

1. Touch the MHz digits.  
(Example: 14)



• Opens the BAND STACKING REGISTER screen.

2. Touch [F-INP].

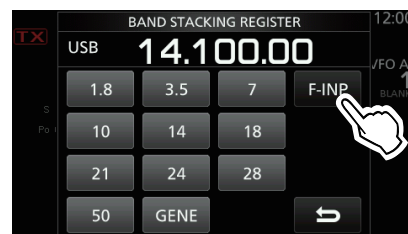

BAND STACKING REGISTER screen

• Opens the F-INP screen.

3. Start entry with the MHz digits.
  - ① To clear the entry, touch [CE].
  - ② To clear the entry and return to the previous screen, push **EXIT**.



F-INP screen (Example:14.025)

4. Touch [ENT] to set the entered frequency.
  - Closes the F-INP screen.
  - ① If you touch [ENT] when the digits under 100 kHz are not entered, "0" will be automatically entered into the digits that are blank.

Entry examples

- 14.025 MHz: [1], [4], [•(-)], [0], [2], [5], [ENT]
- 18.0725 MHz: [1], [8], [•(-)], [0], [7], [2], [5], [ENT]
- 730 kHz: [0], [•(-)], [7], [3], [ENT]
- 5.100 MHz: [5], [•(-)], [1], [ENT]
- 7.000 MHz: [7], [ENT]
- Changing from 21.280 MHz to 21.245 MHz: [•(-)], [2], [4], [5], [ENT]

## Setting the frequency (Continued)

### Entering the Split Frequency Offset

1. Touch the MHz digits.  
(Example: 14)



- Opens the BAND STACKING REGISTER screen.

2. Touch [F-INP].

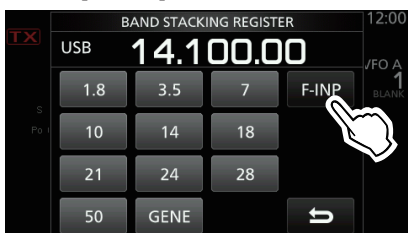

BAND STACKING REGISTER screen

- Opens the F-INP screen.

3. Enter the Split Frequency Offset.

- ① If you want the minus shift direction, touch [•(-)].
- ① Enter the offset between -9.999 MHz and +9.999 MHz (1 kHz steps).



F-INP screen

Touch for -Split

[SPLIT] or  
[-SPLIT] is  
displayed

4. To save the entry, touch [SPLIT] or [-SPLIT].

- Closes the F-INP screen.

#### Entry examples

- 10 kHz: [1], [0], [SPLIT]
- -1.025 MHz: [•(-)], [1], [0], [2], [5], [-SPLIT]
- ① After entering, the Split function is automatically turned ON.

### Entering a Memory channel

1. Touch **V/M** to select the Memory mode.



VFO mode  
(Example: VFO A)

Memory mode  
(Example: Memory channel 1)

2. Touch the MHz digits.  
(Example: 14)



- Opens the BAND STACKING REGISTER screen.

3. Touch [F-INP].

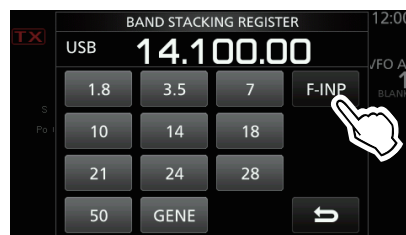

BAND STACKING REGISTER screen

- Opens the F-INP screen.

4. Enter a Memory channel number between 1 and 99. (Memory channel 5)

- ① If you want to set the Program Channel number (P1 or P2), enter "100" for P1, and "101" for P2.



F-INP screen

5. Touch [MEMO] to select the entered channel.

- Closes the F-INP screen.

### ◇ Band Edge Beep

You will hear a Band Edge Beep and **TX** will be displayed when you tune into or out of an amateur band's frequency range.

- ① You can change the Band Edge Beep settings in the following menu.

**MENU** » **SET > Function > Band Edge Beep**

Setting the frequency (Continued)

◇ Entering a Band Edge

When “ON (User)” or “ON (User) & TX Limit” is selected on the “Band Edge Beep” screen, you can enter a total of 30 band edge frequencies.

- ① Initially, all band edges are entered. Therefore, you must first edit or delete them to enter a new band edge.
- ① You cannot enter an overlapped frequency or a frequency that is out of the preset transmit frequency.

1. Open the “Band Edge Beep” screen.

**MENU** » **SET > Function > Band Edge Beep**

2. Select “ON (User)” or “ON (User) & TX Limit.”
  - ① If you select “ON (User) & TX Limit,” you can limit transmission to within the entered frequency range.

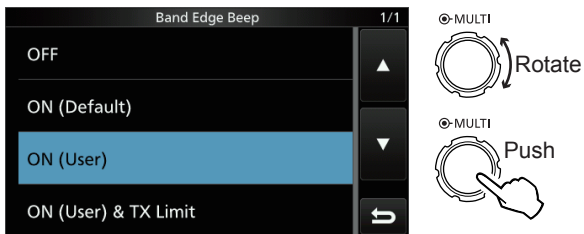

“Band Edge Beep” screen

3. Select “User Band Edge.”

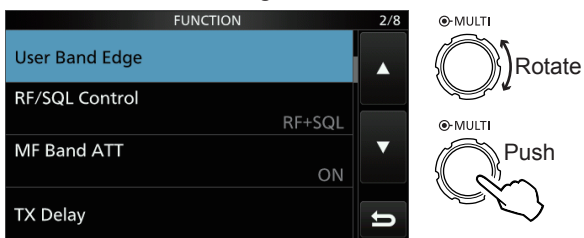

FUNCTION set screen

- Opens the “User Band Edge” screen.

Editing a Band Edge

You can edit a band edge entered as a default or when entering a new band edge.

1. On the FUNCTION set screen, select “User Band Edge.”
2. Touch the band edge you want to edit for 1 second.  
(Example: 5: 14.000.000 – 14.350.000 MHz)

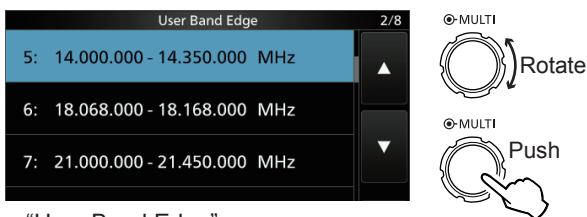

“User Band Edge” screen

3. Edit the lower band edge frequency.  
(Example: 14.1)

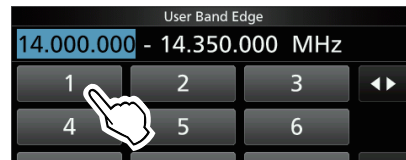

Entry examples

- 14.025 MHz: [1], [4], [•], [0], [2], [5], [ENT]
- 18.0725 MHz: [1], [8], [•], [0], [7], [2], [5], [ENT]
- 730 kHz: [0], [•], [7], [3], [ENT]
- 5.100 MHz: [5], [•], [1], [ENT]
- 7.000 MHz: [7], [ENT]
- Changing from 21.280 MHz to 21.245 MHz: [•], [2], [4], [5], [ENT]

4. Touch [ENT] to save the edited lower band edge frequency.

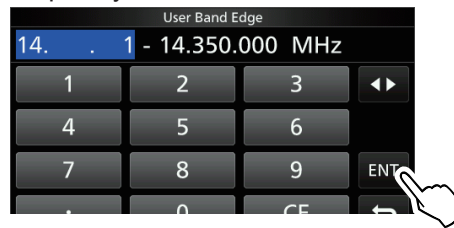

5. Edit the upper band edge frequency.  
(Example: 14.25)

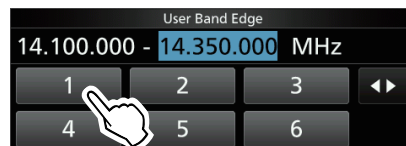

6. Touch [ENT] to save the edited upper band edge frequency.

- ① The edited band edge is saved and returns to the previous screen.

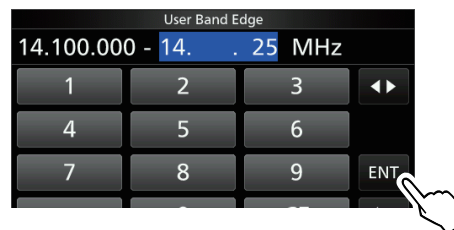

TIP:

- You can also edit the frequency by rotating **MAIN DIAL** or **MULTI**.
- Each band edge must be higher in frequency than the ones above it. If you try to enter a lower frequency than the edge above, the lower frequency edge will be cleared when you push [ENT].

## Setting the frequency

### ◇ Entering a Band Edge (Continued)

#### Deleting a Band Edge

To enter a new band edge, first you must delete a preset band edge.

1. On the FUNCTION set screen, select “User Band Edge.”
2. Touch the desired band edge to delete for 1 second.

(Example: 1: 1.800.000 – 1.999.999 MHz)

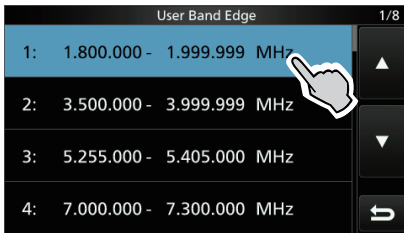

“User Band Edge” screen

3. Touch “Delete.”

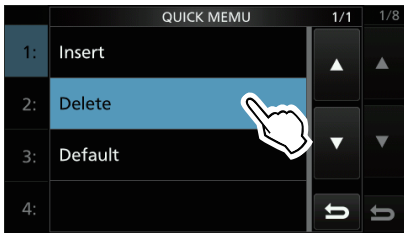

- The selected band edge is deleted and returns to the previous screen.

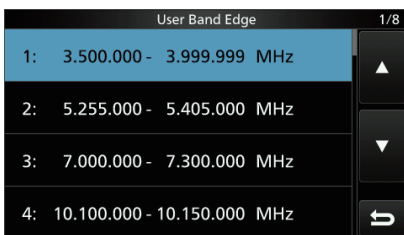

1.800.000 – 1.999.999 MHz is deleted.

#### Entering a new Band Edge

After you delete or edit the preset band edges, you can enter a new band edge.

1. Open the “User Band Edge” screen.
2. Select a blank band.  
(Example: 10)

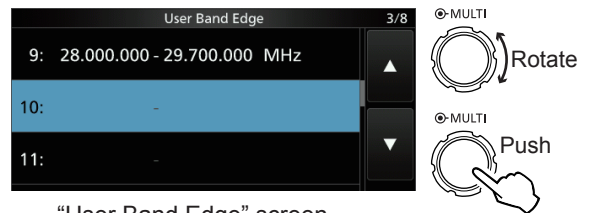

“User Band Edge” screen

3. Enter the lower band edge frequency.  
(Example: 51.15)

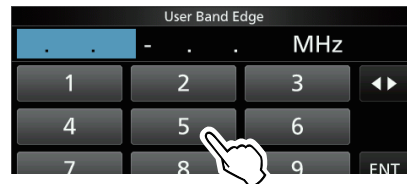

4. Touch [ENT] to save the entered lower band edge frequency.



5. Enter the upper band edge frequency.  
(Example: .75)

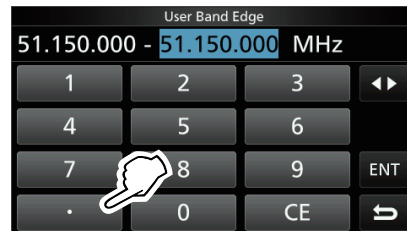

6. Touch [ENT] to save the entered upper band edge frequency.

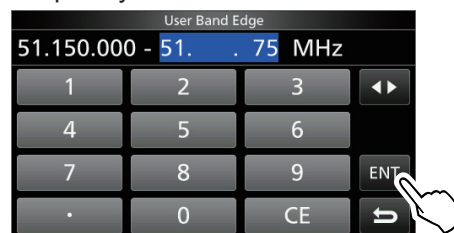

- The entered band edge is saved and returns to the previous screen.

**Setting the frequency**

◇ Entering a Band Edge (Continued)

**Inserting a Band Edge**

After you delete or edit the preset band edges, follow the steps below to insert a band edge.

1. Open the “User Band Edge” screen.
2. Touch the band edge you want to insert a new band edge above for 1 second.  
(Example: 1: 3.500.000–3.999.999 MHz)  
① The new band edge will be inserted above the selected band edge.

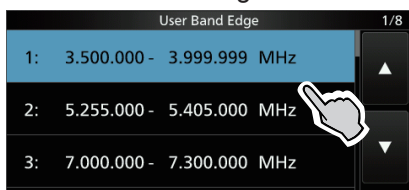

“User Band Edge” screen

3. Touch “Insert.”

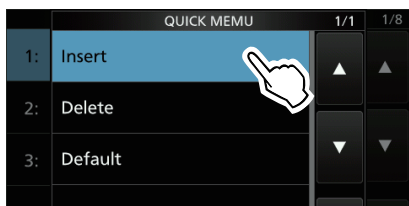

4. Enter the lower band edge frequency.  
(Example: 1.85)



5. Touch [ENT] to save the entered lower band edge frequency.

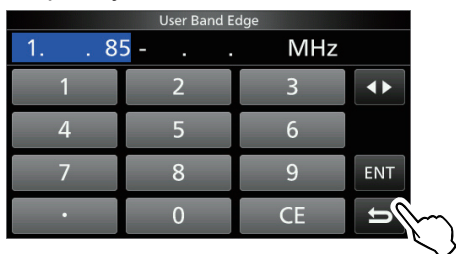

6. Enter the upper band edge frequency.  
(Example: .95)

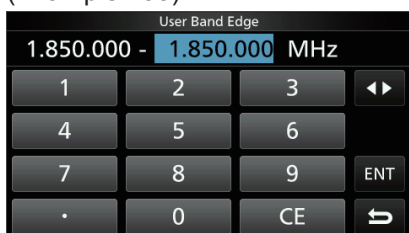

7. Touch [ENT] to save the entered upper band edge frequency.  
• The entered band edge is saved and returns to the previous screen.

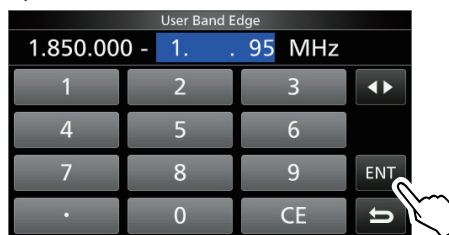

3

**Resetting all band edges to presets**

The steps below will reset all the band edges to their initial settings. All entered settings will be deleted.

1. Open the “User Band Edge” screen.
2. Touch any band edge for 1 second.

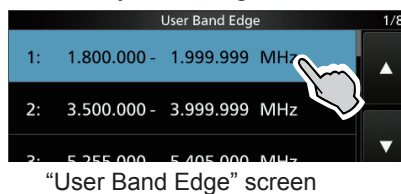

“User Band Edge” screen

3. Touch “Default.”

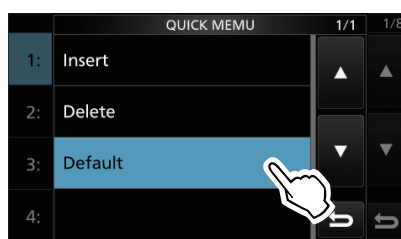

• Displays “Reset All Edges?”

4. Touch [YES].  
• All the band edges reset to the initial settings.

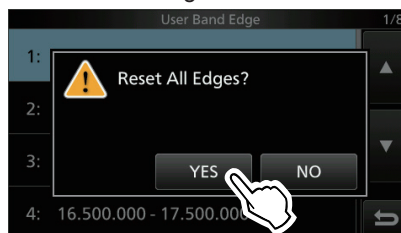

## RF gain and SQL level

Rotate (AF/RF/SQL)(outer) to adjust the RF gain and SQL level.

By default, rotating to left (when set to the 12 o'clock position) adjusts the RF gain, and rotating to right adjusts the squelch level as described below.

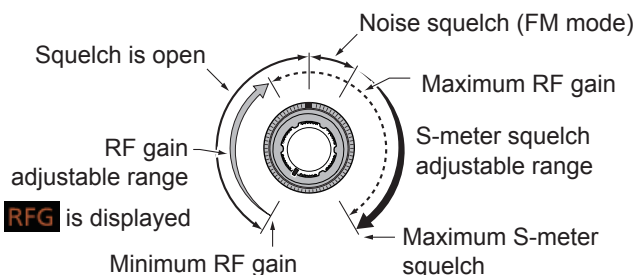

### RF gain

Adjust the RF gain to decrease the noise received from a nearby strong station.

- Rotate counterclockwise to reduce the RF gain, which reduces the receive sensitivity. "RFG" indicates that the RF gain is reduced.

① If a strong signal is received and "OVF" (Overflow) appears, reduce the RF gain until "OVF" disappears.

### SQL level

There are 2 types of SQL level, depending on the operating mode.

#### • Noise squelch

Rotate the (AF/RF/SQL)(outer) until the noise just disappears and the TX/RX indicator goes OFF.

#### • S-meter squelch

The S-meter squelch disables the audio output from the speaker or headphones when the received signal is weaker than the specified S-meter squelch level.

Rotate the (AF/RF/SQL) clockwise from the 12 o'clock position to adjust the S-meter threshold level.

① You can change the (AF/RF/SQL)(outer) control type in "RF/SQL Control." (p. 8-3)

**MENU** » **SET > Function > RF/SQL Control**

## Dial Lock function

The Dial Lock function prevents frequency changes caused by accidentally moving (MAIN DIAL).

① This function electronically locks the dial.

Hold down (SPEECH) for 1 second to turn the Dial Lock function ON or OFF.

- "LO" is displayed while the function is ON.
- During Split Frequency operation, the Split Lock function may be turned ON. (p. 8-4)

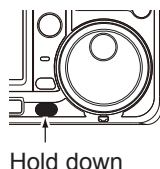

**MENU** » **SET > Function > Lock Function**

## Basic transmission

1. Push **TRANSMIT** or [PTT] to transmit.
  - The TX/RX indicator lights red and **TX** is displayed while transmitting.
2. Push **TRANSMIT** or release [PTT].
  - Returns to receive.

## Adjusting the transmit output power

Before transmitting, monitor your selected operating frequency to make sure you do not cause interference to other stations on the same frequency. It is good amateur practice to listen first, and then, even if nothing is heard, ask if the frequency in use once or twice, before you start operating.

### ◇ Adjusting the transmit output power

1. Set the operating mode to SSB, CW, RTTY or FM. (p. 3-2)  
(Example: USB)
2. Touch the meter to display the Po meter. (p. 3-10)
3. Open the Multi-function menu.

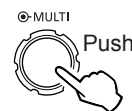

4. Push **TRANSMIT** or hold down [PTT].
  - The Po meter level changes according to your voice level in the SSB mode.
  - The TX/RX indicator lights red and **TX** is displayed.
5. Touch "RF POWER."
6. Adjust the transmit output power to between 0 and 100%.

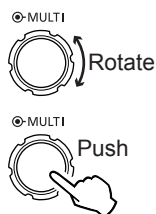
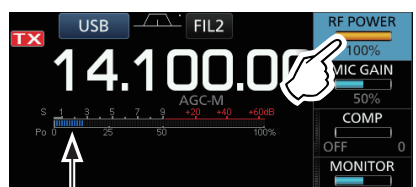
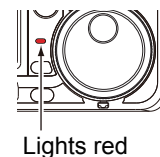

Po meter

- The Po meter displays the RF output power in a percentage. It becomes the S-meter while receiving.
7. Push **TRANSMIT** or release [PTT].
    - Returns to receive.



## Meter display

### ◇ Meter display selection

You can display one of the 6 different transmit parameters (Po, SWR, ALC, COMP, VD and ID) for your convenience.

Touch the parameter to display one of the meters.

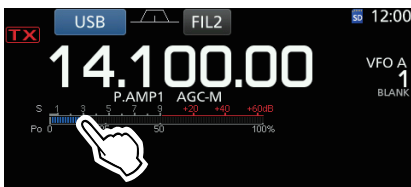

### ◇ Multi-function meter

You can display all the parameters simultaneously.

① The TEMP meter is also displayed on the Multi-function meter.

Hold down the parameter for 1 second to display the Multi-function meter.

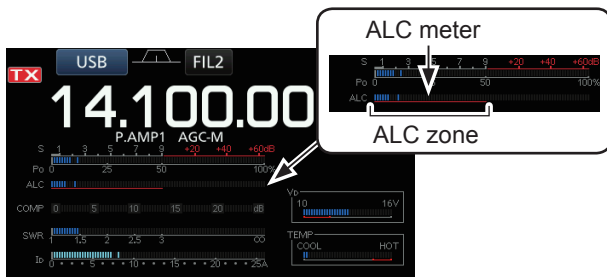

Multi-function meter

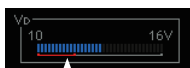

Displays the drain voltage of the final amplifier MOS-FETs.



Displays the temperature of the final amplifier MOS-FETs.

TX inhibit zone

- S:** Displays the receiving signal strength level.
- Po:** Displays the relative RF output power.
- SWR:** Displays the SWR of the antenna at the frequency.
- ALC:** Displays the ALC level. When the meter movement shows the input signal level exceeds the allowed level, the ALC limits the RF power. In such cases, decrease the microphone gain level.
- COMP:** Displays the compression level when the speech compressor is used.
- VD:** Displays the drain voltage of the final amplifier MOS-FETs.
- ID:** Displays the drain current of the final amplifier MOS-FETs.
- TEMP:** Displays the temperature of the final amplifier MOS-FETs.

## Adjusting the microphone gain

Adjust the microphone gain as described below.

1. Set the operating mode to between SSB, AM and FM. (p. 3-2)
2. Push **(MULTI)** to display the Multi-function menu.
3. Touch "MIC GAIN."

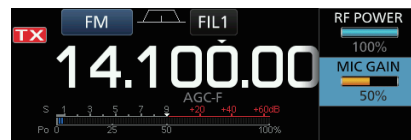

4. Push **(TRANSMIT)** or hold down [PTT] on the microphone.
  - The TX/RX indicator lights red and **TX** is displayed.

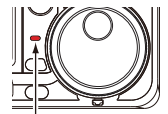

Lights red

5. Rotate **(MULTI)** to adjust the microphone gain.

### ① Information

- In the SSB mode, touch the TX meter to select the ALC meter and adjust until the meter reading swings between 30 to 50% of the ALC scale.
- Hold the microphone 5 to 10 cm (2 to 4 inches) from your mouth, then speak at your normal voice level.
- In the AM or FM mode, check the audio clarity with another station, or use the Monitor function (p. 4-8).

6. Push **(TRANSMIT)** or release [PTT].
  - Returns to receive

## About the 5 MHz frequency band operation (USA version only)

Operation on the 5 MHz frequency band is allowed on 5 discrete frequencies and you must adhere to the following:

- The USB, USB Data, PSK, and CW modes.
- Maximum of 100 watts ERP (Effective Radiated Power)
- Maximum 2.8 kHz bandwidth

It is your responsibility to set all controls so that transmission in this frequency band meets the stringent conditions under which amateur operations may use these frequencies.

**TIP:** We recommend that you save these frequencies, modes and filter settings into memory channels, for easy recall.

**NOTE:** To assist you in operating within the rules specified by the FCC, transmission is illegal on any frequencies other than the five shown in the tables below.

**For the USB and USB data modes:**

The FCC specifies center frequencies on the 5 MHz frequency band. However, the transceiver displays carrier frequency. Therefore, tune the transceiver to 1.5 kHz below the specified FCC channel center frequency.

Transceiver displayed frequency	FCC channel center frequency
5.33050 MHz	5.33200 MHz
5.34650 MHz	5.34800 MHz
5.35700 MHz	5.35850 MHz
5.37150 MHz	5.37300 MHz
5.40350 MHz	5.40500 MHz

**For the CW mode:**

The transceiver displays the center frequency. Therefore, tune the transceiver to the specified FCC channel frequency when you operate in the CW mode.

Transceiver displayed frequency	FCC channel center frequency
5.33200 MHz	5.33200 MHz
5.34800 MHz	5.34800 MHz
5.35850 MHz	5.35850 MHz
5.37300 MHz	5.37300 MHz
5.40500 MHz	5.40500 MHz

## Preampifiers

The preamps amplify received signals in the receiver front end to improve the signal-to-noise ratio and sensitivity. A preamp is used when receiving weak signals.

① Each band memorizes the Preampifier setting.

Push **P.AMP** (P.AMP).

① Each push changes between “P.AMP1,” “P.AMP2,” and OFF (no icon).



Displayed when the preamp is used.  
(Example: P.AMP1)

<b>P.AMP1</b>	Wide dynamic range preamplifier. It is most effective for the HF low bands.
<b>P.AMP2</b>	High-gain preamplifier. It is most effective for the 50 MHz bands.

**NOTE:** When you use the preamp while receiving strong signals, the receiving signal may be distorted. In such case, turn OFF the preamp.

## Attenuator

The Attenuator prevents a desired signal from becoming distorted when a very strong signal is near the frequency, or when a very strong electric field, such as from a broadcasting station, is near your location.

① Each band memorizes the Attenuator setting.

Hold down **P.AMP** (ATT) for 1 second to turn ON the Attenuator.

① Pushing **P.AMP** turns OFF the Attenuator (no icon).



Displayed when the Attenuator is ON

## RIT function

The RIT (Receive Increment Tuning) function compensates for differences in frequencies of other stations.

The function shifts the receive frequency up to  $\pm 9.99$  without shifting the transmit frequency.

1. Push **RIT**.

• The RIT function turns ON.

① While using the Fine Tuning function (p. 3-3), the RIT frequency is displayed in 4 digits, instead of 3.

① Pushing **RIT** again turns OFF the RIT function.



RIT frequency (3 digits)

2. Set the RIT frequency to match the receiving station's frequency.



Set RIT frequency.

① You can reset the RIT frequency to “0.00” by holding down **CLEAR** for 1 second.

① You can add the frequency shift to the operating frequency by holding down **RIT** for 1 second.

3. After communicating, push **RIT** to turn the RIT function OFF.

### ◇ RIT monitor function

When the RIT function is ON, you can directly monitor the operating frequency by holding down **XFC**.

① While monitoring, the RIT function is temporarily OFF.

① While monitoring, the settings for the Noise Reduction, Notch filter and Twin PBT are temporarily OFF.

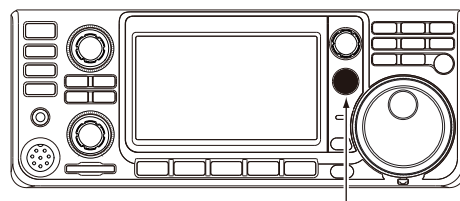

While holding down **XFC**.

## AGC function control

The AGC (Automatic Gain Control) controls receiver gain to produce a constant audio output level, even when the received signal strength varies greatly.

### ◇ Selecting the AGC time constant preset value

The transceiver has 3 preset AGC settings for all modes except for the FM mode (time constants: FAST, MID and SLOW).

1. Select the operating mode.  
(Example: SSB)
2. Push **FUNCTION**.  
• Opens the FUNCTION screen.
3. Touch [AGC] to select the desired time constant.  
① Touching [AGC] selects FAST, MID or SLOW.  
② For the FM mode, FAST is fixed.



FUNCTION screen (SSB mode)

4. To close the FUNCTION screen, **EXIT**.

### ◇ Setting the AGC time constant

You can set the preset AGC time constant to the desired value.

1. Select the operating mode.  
(Example: SSB)
2. Push **FUNCTION**.  
• Opens the FUNCTION screen.
3. Touch [AGC] for 1 second.

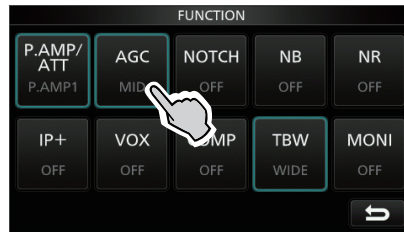

FUNCTION screen (SSB mode)

- Opens the AGC (SSB) screen.

4. Touch either FAST, MID or SLOW to select the desired AGC to adjust the time constant.  
(Example: MID)



AGC (SSB) screen (SSB mode)

You can reset to the default settings by touching this key for 1 second.

5. Rotate **MAIN DIAL** to set the time constant.  
① The adjustable time constants are described in the table below.
6. To close the AGC (SSB) screen, push **EXIT**.

#### • Selectable AGC Time constant (unit: seconds)

Mode	Default	Adjustable time constant
LSB USB	0.3 (FAST)	OFF, 0.1, 0.2, 0.3, 0.5, 0.8, 1.2, 1.6, 2.0, 2.5, 3.0, 4.0, 5.0 or 6.0
	2.0 (MID)	
	6.0 (SLOW)	
CW/RTTY	0.1 (FAST)	OFF, 0.1, 0.2, 0.3, 0.5, 0.8, 1.2, 1.6, 2.0, 2.5, 3.0, 4.0, 5.0 or 6.0
	0.5 (MID)	
	1.2 (SLOW)	
AM	3.0 (FAST)	OFF, 0.3, 0.5, 0.8, 1.2, 1.6, 2.0, 2.5, 3.0, 4.0, 5.0, 6.0, 7.0 or 8.0
	5.0 (MID)	
	7.0 (SLOW)	
FM	0.1 (FAST)	Fixed

**NOTE:** When you are receiving weak signals, and a strong signal is momentarily received, the AGC function quickly reduces the receiver gain. When that signal disappears, the transceiver may not receive the weak signal because of the AGC action. In that case, select FAST, or touch [AGC] for 1 second to open the AGC screen, and then select OFF the time constant setting.

## Using the Twin PBT

### SSB, CW, RTTY and AM modes

In general, the Twin PBT (Passband Tuning) electronically narrows the IF passband width by shifting the IF frequency to slightly outside of the IF filter passband, to reject interference. The IC-7300 uses DSP for the PBT function.

You can narrow the IF passband width by rotating both **TWIN PBT CLR** inner (PBT1) and outer (PBT2) to the opposite direction from each other.

① You can see the nearby signal using the Spectrum Scope (Section 5).

1. Rotate **TWIN PBT CLR** inner (PBT1) and outer (PBT2) to the opposite direction from each other.



#### ① Information

- Match both the **TWIN PBT CLR** (inner) (PBT1) and outer (PBT2) filters before operating the Twin PBT.
- Rejects interference of both higher and lower passbands.
- If you rotate the control too much, the received audio may not be heard because the passband width is too narrow.
- Displays the passband width and shift value.
- A dot is displayed above the passband width when you rotate **TWIN PBT CLR**.
- Hold down **TWIN PBT CLR** for 1 second to clear the PBT setting (the dot disappears).
- The PBT is adjustable in 50 Hz steps in the SSB, CW, and RTTY modes, and 200 Hz in the AM mode. In this case, the center shift value changes in 25 Hz steps in the SSB, CW, and RTTY modes, and 100 Hz in the AM mode.
- Rotating both the inner and outer controls to the same position shifts the IF left or right.

2. Touch the Filter icon for 1 second to display the current passband width and shift frequency.
  - Opens the FILTER screen.

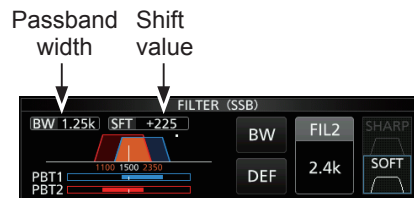

FILTER (SSB) screen (while operating Twin PBT)

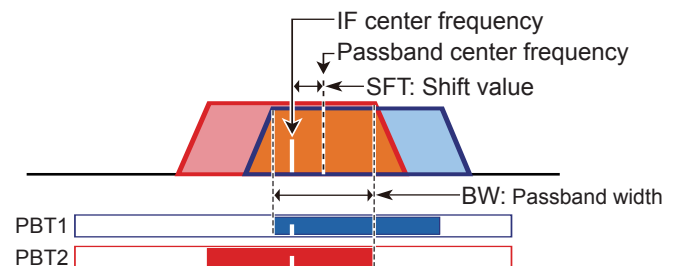

3. To close the FILTER screen, push **EXIT**.

**NOTE:** While rotating **TWIN PBT CLR**, you may hear noise. This comes from the DSP unit and does not indicate an equipment malfunction.

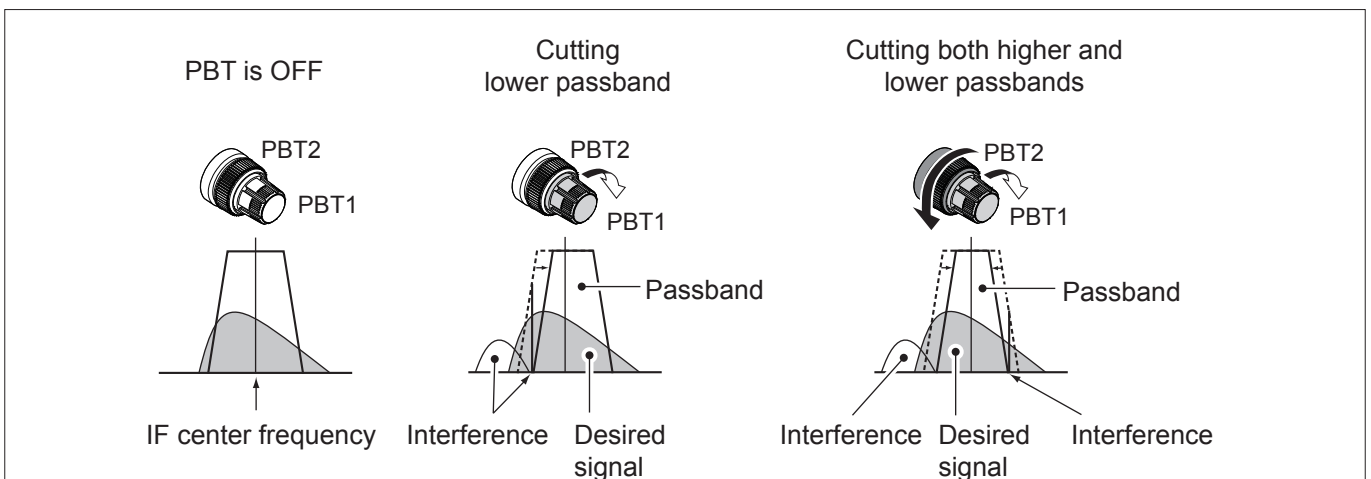

## Selecting the IF filter

The transceiver has 3 IF filter passband widths for each mode, and you can select them on the FILTER screen. You can set the IF filter to wide (FIL 1), mid (FIL 2) or narrow (FIL 3).

1. Select the operating mode.  
(Example: USB)
2. Touch the filter icon for 1 second.  
• Opens the FILTER (SSB) screen.



3. Touch the filter icon more times to select FIL 1 (wide), FIL 2 (mid) or FIL 3 (narrow).
4. Touch [BW].  
• Selects the passband width mode.



FILTER (SSB) screen (when FIL 2 is selected)

5. Rotate **(MAIN DIAL)** to select the passband width.  
① You cannot change the passband width in the FM or FM-D mode.  
② When you change the passband width, the Twin PBT setting value is reset to the center position.

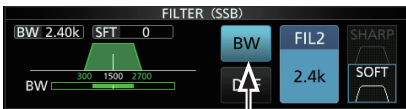

Passband width mode

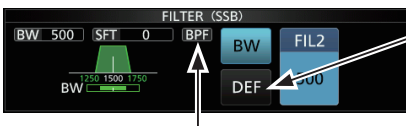

Touch for 1 second to reset to default.

Displayed when a band width less than 500 Hz is selected in the SSB or CW mode.

6. Touch [BW].  
• Cancels the passband width mode.
7. Repeat steps 2 to 6 to set the passband width for other modes except for the FM and FM-D.
8. To close the FILTER screen, push **(EXIT)**.

**TIP:** When you set the IF filter to FIL2 or FIL3 in the FM mode, the transceiver will transmit in the FM narrow mode.

Mode	IF filter	Selectable range (steps)
SSB	FIL 1 (3.0 kHz)	50Hz to 500Hz (50 Hz)/ 600Hz to 3.6kHz (100 Hz)
	FIL 2 (2.4 kHz)	
	FIL 3 (1.8 kHz)	
SSB-D CW	FIL 1 (1.2 kHz)	50Hz to 500Hz (50 Hz)/ 600Hz to 3.6kHz (100 Hz)
	FIL 2 (500 Hz)	
	FIL 3 (250 Hz)	
RTTY	FIL 1 (2.4 kHz)	50Hz to 500Hz (50 Hz) 600Hz to 2.7kHz (100 Hz)
	FIL 2 (500 Hz)	
	FIL 3 (250 Hz)	
AM AM-D	FIL 1 (9.0 kHz)	200Hz to 10.0kHz (200 Hz)
	FIL 2 (6.0 kHz)	
	FIL 3 (3.0 kHz)	
FM FM-D	FIL 1 (15 kHz)	Fixed
	FIL 2 (10 kHz)	
	FIL 3 (7.0 kHz)	

## Selecting the IF filter shape

You can independently select the DSP filter shape for operating modes to soft or sharp.

1. Set the operating mode to SSB, SSB-D or CW.  
(Example: USB)
2. Touch the filter icon for 1 second.  
• Opens the FILTER screen.



3. Touch the filter icon several times to select FIL1 (wide), FIL2 (mid) or FIL3 (narrow).
4. Touch [SHARP] or [SOFT].



When [SOFT] is selected

5. To close the FILTER screen, push **(EXIT)**.



Selecting the IF filter shape (Continued)

• SHARP

This selection is to emphasize the passband width of the filter. The filter has an almost ideal shape factor. Signals of the out of passband are extremely filtered out and it gives you better audio quality.

• SOFT

The filter shoulders are roundly formed as in analog filters. This decreases noise components in the high and low frequencies of the filter passband and increases the S/N of the target signal. These characteristics play an effective role in picking up very weak signals in the 50 MHz band, for example. The shape factor is kept, and the sharpness of the bandpass is excellent.

IP Plus function

The IP Plus function improves the Intermodulation Distortion (IMD) quality by exerting the direct sampling system performance.

This function optimizes the Analog/Digital Converter (ADC) against the distortion when you receive a strong input signal. It also improves the Third-order Intercept Point (IP3) while minimizing the reduction of the receive sensitivity.

1. Push **FUNCTION**.
  - The FUNCTION screen is displayed.
2. Touch **[IP+]**.
  - ① Touch **[IP+]** to turn the IP Plus function ON or OFF.
  - ① Select ON to prioritize the IP quality, and select OFF to prioritize the receive sensitivity.



3. To close the FUNCTION screen, push **EXIT**.
  - "IP+" is displayed when ON is selected.



Noise Blanker

The Noise blanker eliminates pulse-type noise such as the noise from car ignitions. The Noise blanker cannot be used in the FM mode.

Push **NB** to turn the Noise Blanker ON or OFF.



**NOTE:** When using the Noise Blanker, received signals may be distorted if they are excessively strong or the noise is other than a pulse type. In that case, turn the OFF Noise Blanker, or shallow the DEPTH on the NB menu. See the description below for details.

◇ Adjusting the NB level and time

To deal with various type of noise, you can adjust the attenuation level and noise width in the NB menu.

1. Hold down **NB** for 1 second.
  - Turns ON the Noise Blanker and opens the NB menu.
2. Touch the adjusting item. (Example: DEPTH)

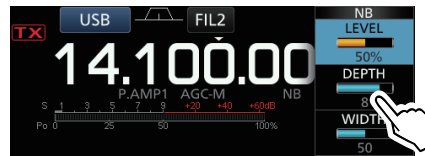

3. Adjust the level. (Example: 8)



**LEVEL** (Default: 50%)

Adjust the level where the Noise Blanker activates between 0 and 100%.

**DEPTH** (Default: 8)

Adjust the noise attenuation level between 1 and 10.

**WIDTH** (Default: 50)

Adjust the blanking duration time between 1 and 100.

## Noise Reduction

The Noise Reduction function reduces random noise components and enhances desired signals that are buried in noise. The Noise Reduction function uses the DSP circuit.

Push **[NR]** to turn the Noise Reduction function ON or OFF.

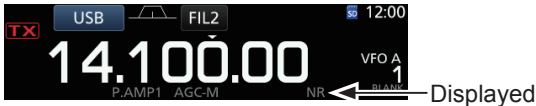

### ◇ Adjusting the Noise Reduction level

Adjust the Noise Reduction level to where noise is reduced and the received signal is not distorted.

1. Hold down **[NR]** for 1 second.
  - Turns ON the Noise Reduction function and opens the NR menu.
2. Adjust the Noise Reduction level to between 0 and 15.
  - ① Adjust to a higher level to increase the reduction level, and a lower level to decrease it.

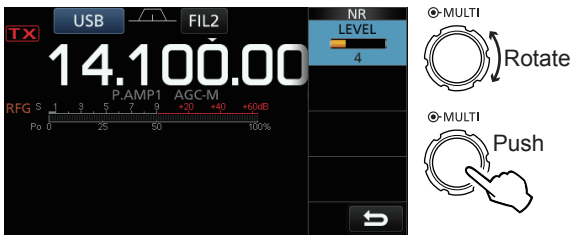

Noise Reduction OFF  
NR level 0

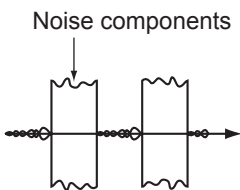

Noise Reduction ON  
NR level 4

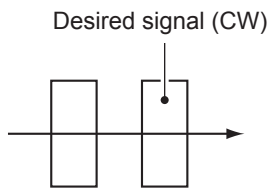

## Notch Filter

The IC-7300 has Auto Notch and Manual Notch functions.

Auto Notch: Used in the SSB, AM and FM modes.  
Manual Notch: Used in the SSB, CW, RTTY and AM modes.

### ◇ Auto Notch function

Auto Notch automatically attenuates beat tones, tuning signals and so on.

Push **[NOTCH]** until "AN (Auto Notch)" is displayed.  
① Pushing **[NOTCH]** changes between "AN (Auto Notch)," "MN (Manual Notch)" and OFF.



### ◇ Manual Notch function

The Manual Notch attenuates beat tones, tuning signals and so on by adjusting a frequency in the NOTCH menu.

1. Hold down **[NOTCH]** for 1 second to display the NOTCH menu.
  - The Manual Notch is automatically selected and "MN" is displayed.
  - ① Pushing **[WIDTH]** sets the Manual Notch filter width to "WIDE," "MID" or "NAR."
2. Slowly adjust the POSITION to manually attenuate the frequency.



**NOTE:** While adjusting, noise may be heard. This comes from the DSP unit and does not indicate an equipment malfunction.

## VOX function

The VOX (Voice-Operated Transmission) function switches between transmit and receive with your voice. This function enables a hands-free operation.

### ◇ Adjusting the VOX function

Before using the VOX function, adjust the following items.

- VOX GAIN
- ANTI VOX
- DELAY
- VOICE DELAY

1. Hold down **VOX/BK-IN** for 1 second.
  - Opens the VOX menu.
2. Touch the adjusting item.  
(Example: ANTI VOX)



3. Adjust the selected item.
  - ① Adjust to the point where the transceiver does not switch to transmit due to the sound from the speaker or other devices.
  - ② Touching VOICE DELAY selects "SHORT," "MID," "LONG" or "OFF."

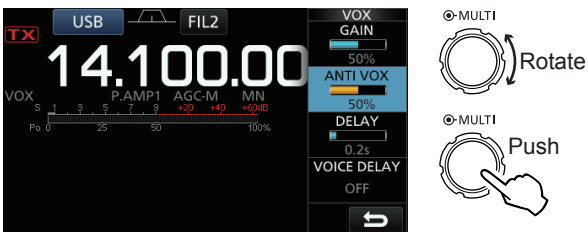

### VOX GAIN (Default: 50%)

Adjust the transmit/receive switching threshold level to between 0% and 100% for VOX operation. Higher values make the VOX function more sensitive to your voice.

### ANTI VOX (Default: 50%)

Adjust the ANTI VOX level to between 0% and 100% to prevent unwanted VOX activation from the speaker or other sounds. Higher values make the VOX function less sensitive.

### DELAY (Default: 0.2s)

Adjust the DELAY to between 0 and 2.0 seconds, for a convenient interval for normal pauses in speech before returning to receive.

### VOICE DELAY (Default: OFF)

Set the VOICE DELAY to prevent picking up your voice when switching to transmit. Select "SHORT," "MID," "LONG" or OFF.

### ◇ Turning ON the VOX function

1. Set the operating mode to SSB, AM or FM.  
(Example: USB)
2. Push **VOX/BK-IN** to turn ON the VOX function.
  - ① Pushing **VOX/BK-IN** again turns OFF the VOX function.



## ΔTX function

The ΔTX function shifts the transmit frequency up to ±9.99 kHz without shifting the receive frequency.

1. Push **ΔTX**.
  - The ΔTX function turns ON.
  - ① Pushing **ΔTX** turns the ΔTX function ON or OFF.
  - ① While using the Fine Tuning function (p. 3-3), the ΔTX frequency is displayed in 4 digits, instead of 3.

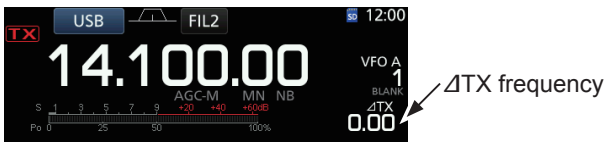

2. Set the ΔTX frequency to match the receiving station's frequency.

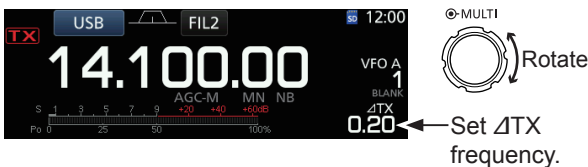

- ① To reset the ΔTX frequency to "0.00," hold down **CLEAR** for 1 second.
  - ① You can add the frequency shift to the operating frequency by holding down **ΔTX** for 1 second.
3. After communicating, push **ΔTX** to turn the ΔTX function OFF.

### ◇ ΔTX monitor function

When the ΔTX function is ON, you can directly monitor the operating frequency by holding down **XFC**.

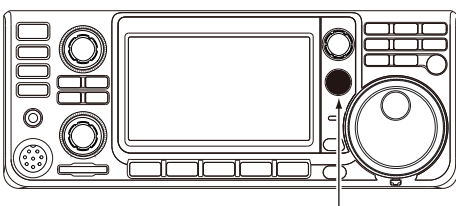

While holding down **XFC**.

## Monitor function

The Monitor function enables you to monitor your transmit audio. Use this function to check the voice characteristics while adjusting transmit audio parameters.

① You can hear the CW sidetone regardless of the Monitor function setting.

1. Select the mode that you want to monitor. (Example: USB)
2. Push **FUNCTION**.
  - Opens the FUNCTION screen.
3. Touch [MONI] to turn ON the Monitor function.
  - ① Touching [MONI] turns the Monitor function ON or OFF.



FUNCTION screen (USB mode)

4. Touch [MONI] for 1 second.



5. Adjust MONITOR to the clearest audio output between 0% and 100%, while speaking at your normal voice level.

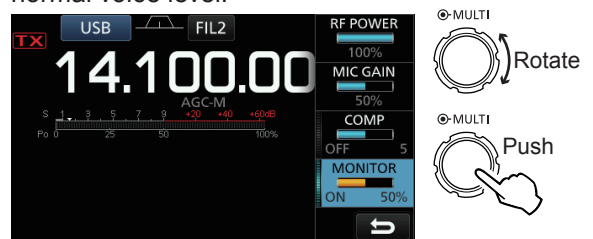

**NOTE:** When using the VOICE DELAY (p. 4-7), turn OFF the Monitor function. Otherwise the transmitted audio will echo.

# Setting the Speech Compressor

## SSB mode

The Speech Compressor increases the average RF output power, improving readability at the receiving station. This function compresses the transmitter audio input to increase the average audio output level.

① The function is effective for long-distance communication, or when propagation conditions are poor.

1. Select the SSB mode.  
(Example: USB)
2. Push **FUNCTION**.  
• Opens the FUNCTION screen.
3. Be sure that the Speech Compressor is OFF.  
① If the Speech Compressor is ON, touch [COMP] to turn it OFF.

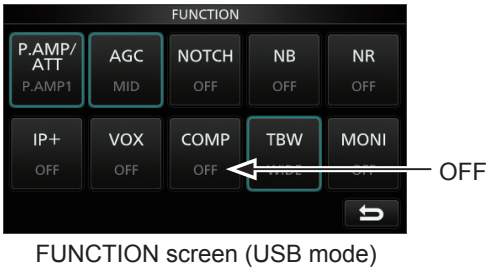

4. Touch **EXIT** to close the FUNCTION screen.
5. Touch the Multi-function meter to display the ALC meter.  
① Touching the Multi-function meter sets the meter to Po, SWR, ALC, COMP, Vd or Id.

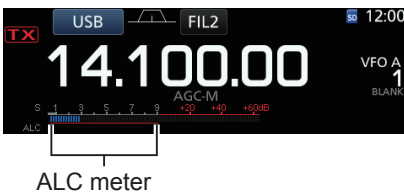

6. Adjust the MIC GAIN (p. 3-10) to where the ALC meter reads within the 30 to 50% range of the ALC zone.
7. Touch the Multi-function meter again to display the COMP meter.
8. Push **FUNCTION**.  
• Opens the FUNCTION screen.
9. Touch [COMP] to turn it ON.



10. Touch [COMP] for 1 second.

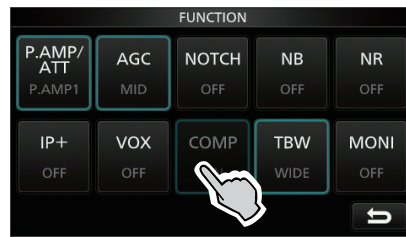

11. While speaking into the microphone at your normal voice level, adjust the Speech Compressor level to where the COMP meter reads within the COMP zone (10 to 20 dB range).  
① When the COMP meter peaks exceed the COMP zone, your transmitted voice may be distorted.





## Split frequency operation

Split frequency operation enables you to transmit and receive on different frequencies in the same or different bands.

There are 2 ways to use the Split frequency operation.

- Use the Quick Split function
- Use the receive and transmit frequencies set to VFO A and VFO B.

Another station		My station	
Transmit frequency	USB mode 21.29000 MHz	VFO A Receive frequency	
Receive frequency	USB mode 21.31000 MHz	VFO B Transmit frequency	

### ◇ Using the Quick Split function

The Quick Split function enables you to automatically equalize the frequency and mode of VFOs to the displayed VFO, and activate the Split function.

1. Set VFO A's receive frequency and operating mode.  
(Example: 21.29000 MHz in the USB mode)
2. Hold down **[SPLIT]** for 1 second.
  - The Quick Split function is turned ON and the VFO A settings are set to VFO B.
  - The VFO B frequency is displayed in the bottom right corner of the main screen.



3. While holding down **[XFC]**, set the operating frequency offset between transmit and receive.



The offset between transmit and receive while holding down **[XFC]**.

### ◇ Using the receive and transmit frequencies set to VFO A and VFO B

1. Set VFO A's receive frequency and operating mode.  
(Example: 21.29000 MHz in the USB mode)

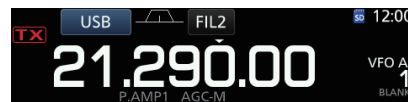

2. Push **[A/B]** to select VFO B, and then set the receive frequency and the operating mode.  
(Example: 21.31000 MHz in the USB mode)

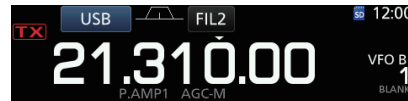

3. Push **[SPLIT]** to turn ON the Split function.  
① Pushing **[SPLIT]** turns the Split function ON or OFF.



4. Push **[A/B]** to return to VFO A.  
① The Split frequency operation is ready.

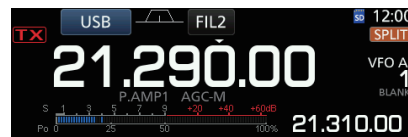



## Split Lock function

The Split Lock function is convenient for changing only the transmit frequency but not changing the receive frequency.

1. Turn ON the Split Lock function.  
**MENU** » **SET > Function > SPLIT > SPLIT LOCK**
2. Turn ON the Split function.
3. Hold down **SPEECH** for 1 second to turn ON the Dial Lock function.
4. While holding down **XFC**, set the transmit frequency.

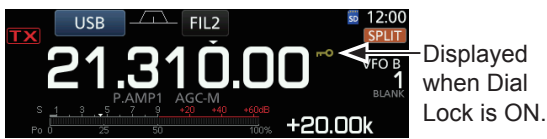

## Setting the transmit filter width

You can select the transmit filter width for the SSB mode to WIDE (wide), MID (middle) or NAR (narrow).

1. Set the operating mode to USB or LSB.
2. Push **FUNCTION**.  
 • Opens the FUNCTION screen.
3. Touch **TBW**.  
 ① Touching **TBW** sets the filter width to WIDE, MID or NAR.



FUNCTION screen (SSB mode)

① The transmit filter widths are set to the following values by default.

- WIDE: 100 Hz to 2900 Hz
- MID: 300 Hz to 2700 Hz
- NAR: 500 Hz to 2500 Hz

You can change the filter width values in the following settings. (p. 8-2)

**MENU** » **SET > Tone Control > TX > SSB > TBW (WIDE)**

**MENU** » **SET > Tone Control > TX > SSB > TBW (MID)**

**MENU** » **SET > Tone Control > TX > SSB > TBW (NAR)**

## Operating CW

### ◇ Setting the CW pitch control

You can set the received CW audio pitch and the CW side tone to suit your preference without changing the operating frequency.

1. Select the CW mode.
2. Display the Multi-function menu.

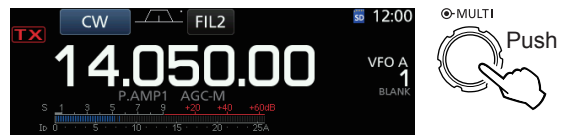

3. Touch **[CW PITCH]**.

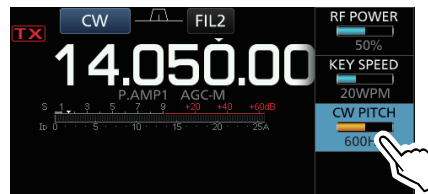

4. Set the CW pitch to between 300 and 900 Hz



## 4 RECEIVING AND TRANSMITTING

### Operating CW (Continued)

#### ◇ Setting the key speed

You can set the key speed of the internal electric keyer.

1. Select the CW mode.
2. Display the Multi-function menu.



3. Touch [KEY SPEED].



4. Set the key speed to between 6 and 48 Words Per Minute (WPM).

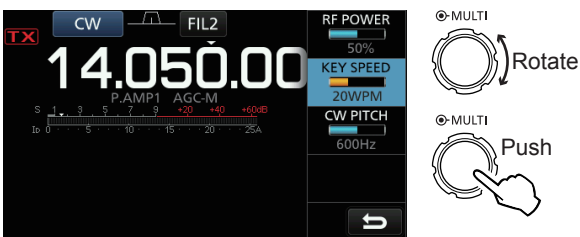

#### ◇ About the Break-in function

Use the Break-in function in the CW mode to automatically switch between transmit and receive when keying. The IC-7300 is capable of Semi Break-in and Full break-in modes.

**TIP:** The key type is set to “Paddle” by default. You can select the keyer type on the CW-KEY SET screen. (p. 4-14)

#### Semi Break-in operation

In the Semi Break-in mode, the transceiver transmits when keying, and then automatically returns to receive after a preset time after you stop keying.

1. Select the CW mode.
2. Push **VOX/BK-IN** to display “BKIN.”  
 ① Pushing **VOX/BK-IN** selects “BKIN (Semi Break-in),” “F-BKIN (Full Break-in)” or OFF (no indication).



3. To adjust the Break-in delay time, hold down **VOX/BK-IN** for 1 second.  
 • Opens the BKIN menu.
4. Set to where the transceiver does not return to receive while keying.



- ① When you are using a paddle, push **MULTI** to display the Multi-function menu, and then adjust the KEY SPEED while operating the paddle.

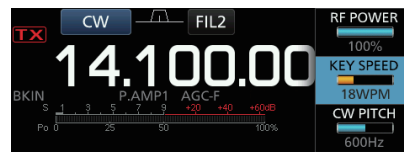

5. To close the BKIN menu, push **EXIT**.

## Operating CW

### ◇ About the Break-in function (Continued)

#### Full Break-in operation

In the Full Break-in mode, the transceiver automatically transmits while keying down, and then immediately returns to receive after keying up.

1. Select the CW mode.
2. Push **VOX/BK-IN** until "F-BKIN" is displayed.  
 ⓘ Pushing **VOX/BK-IN** selects "BKIN (Semi Break-in)," "F-BKIN (Full Break-in)" or OFF (no indication).



3. Using a straight key or paddle.  
 ⓘ In the Full break-in mode, the transceiver automatically returns to receive without a preset break-in delay time after you stop keying. The transceiver receives while keying up.

### ◇ CW Auto Tuning function

You can tune in a CW signal you are receiving using the Auto Tuning function. You can automatically tune by pushing **AUTO TUNE**. This function is active in only the CW mode.

- ⓘ While using the RIT, the RIT frequency is automatically tuned by this function.



**NOTE:** When receiving a weak signal, or receiving a signal with interference, the Auto Tuning function may tune the receiver to an undesired signal, or may not start to tune. In such case, a warning beep sounds.

### ◇ About the CW Reverse mode

The CW-R (CW Reverse) mode reverses the receive Beat Frequency Oscillator (BFO) to receive CW signals.

Use when interfering signals are near the desired signal and you want to use the CW-R to reduce interference.

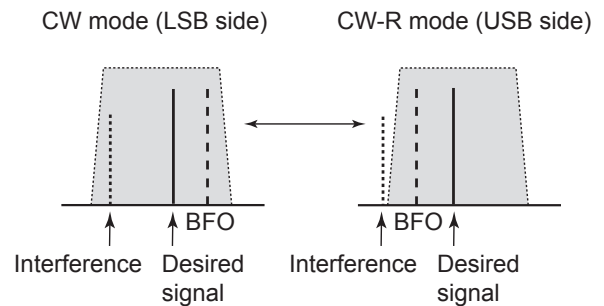

#### TIP: Reversing the carrier point

The carrier point of the CW mode is LSB by default. You can change it to USB in the "CW Normal Side" item of the OTHERS set screen. (p. 8-4)

**MENU** » **SET > Function > CW Normal Side**

- ⓘ When this setting is set to "USB," the CW and CW-R modes are reversed.

Operating CW (Continued)

◇ **Electronic Keyer function**

You can set the Memory Keyer function settings, paddle polarity settings, and so on of the Electronic Keyer.

1. Open the KEYER screen in the CW mode.

**MENU** » **KEYER**

① You can select [KEYER] on the MENU screen only in the CW mode.

2. Touch [EDIT/SET].

• Opens the EDIT/SET screen.



KEYER screen

3. Select the desired item to set.

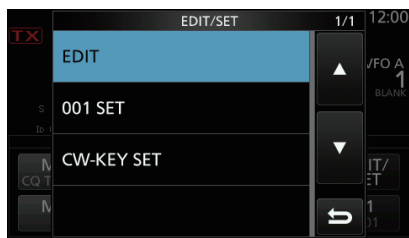

EDIT/SET screen

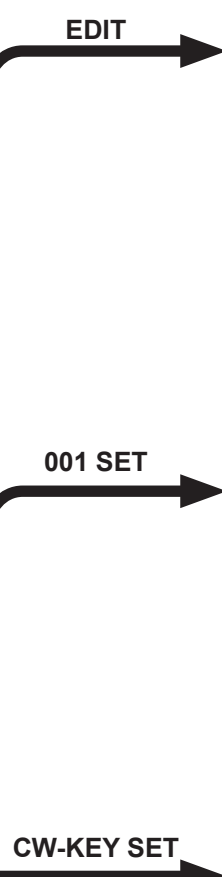
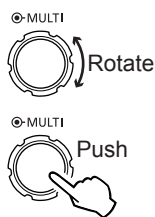

**Keyer memory edit menu**

You can edit the Keyer memories.



**Contest number menu**

You can set the number style, count up trigger, and present number.

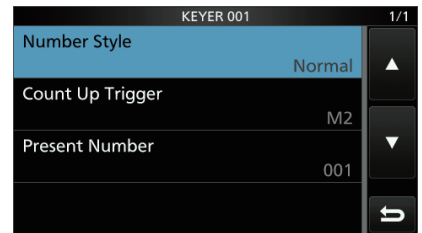

**Key set menu**

You can set the memory keyer repeat time, dot/dash ratio, paddle polarity, key type, and so on.

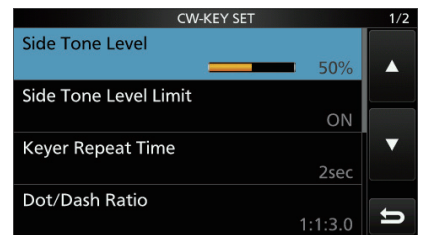

4. To close the KEYER screen, push **EXIT** several times.

◇ **Monitoring the CW side tone**

When the transceiver is in standby and the Break-In function is OFF, you can listen to the CW side tone without actually transmitting.

① **Information**

- This enables you to match your transmit frequency exactly to another station's by matching the audio tone.
- You can also use the CW side tone (make sure the Break-in function is OFF (p. 4-12)) to practice CW sending.
- You can adjust the CW side tone level in "Side Tone Level."

**MENU** » **KEYER > EDIT/SET > CW-KEY SET > Side Tone Level**

## Operating RTTY (FSK)

With the built-in RTTY decoder and the contents set in the RTTY TX memory, you can operate the basic RTTY operation without using an external device.

① If you are using PSK software, refer to the software manual.

1. Select the RTTY mode.
2. Open the RTTY DECODE screen.

**MENU** » **DECODE**

① You can select [DECODE] on the MENU screen only while in the RTTY mode.

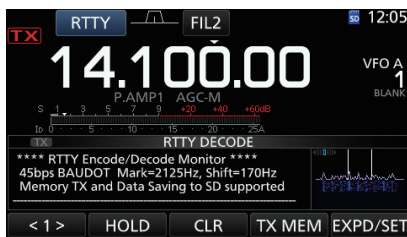

RTTY DECODE screen

3. Rotate **MAIN DIAL** to tune the desired signal.

### ① Information

- Aim for a symmetrical wave form, and be sure the peak points align with the mark (2125 Hz) and shift (170 Hz) frequency lines in the FFT scope.
- The S-meter displays the received signal strength, when a signal is received.
- If you cannot decode correctly, try in the RTTY-R mode.
- Tune to where both “◀” and “▶” are displayed in the tuning indicator.

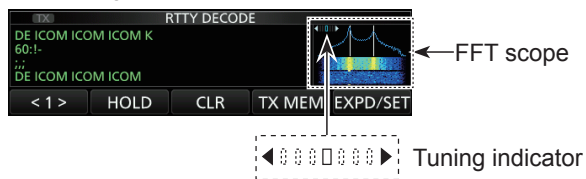

4. Transmit the RTTY memory.

- The TX status indicator lights red and the Po meter swings.

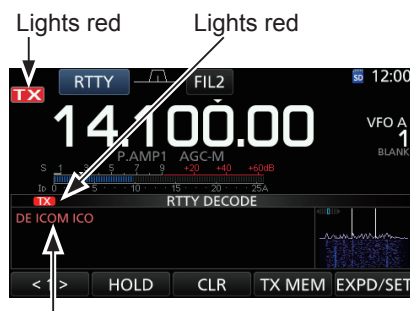

Contents being transmitted are displayed.  
(Example: transmitting the RT1's TX memory)

### ◇ About the RTTY reverse mode

If you are receiving an RTTY signal but cannot decode correctly, try in the RTTY-R (reverse) mode.

Select the RTTY-R mode by touching [RTTY] on the MODE screen.

① Touching [RTTY] toggles between the RTTY mode and the RTTY-R mode.

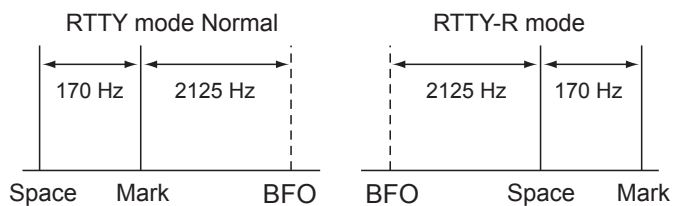

### ◇ Twin Peak Filter

The Twin Peak Filter (TPF) changes the audio frequency response by boosting the mark and space frequencies for better reception of RTTY signals, or for decoding the external AF output on a PC.

1. While in the RTTY mode, display the Multi-function menu.

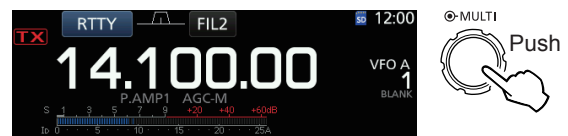

2. Touch [TPF].

① Touching [TPF] turns the function ON or OFF.

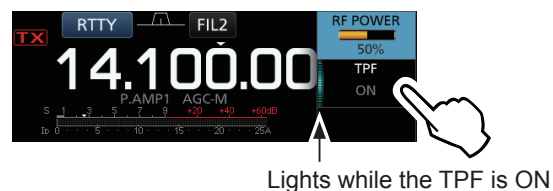

Lights while the TPF is ON

3. To close the Multi-function menu, push **EXIT**.

**NOTE:** When you are using the Twin Peak Filter, the received audio output may increase. This is not a malfunction.

Operating RTTY (FSK) (Continued)

◆ Functions on the RTTY DECODE screen

Open the RTTY DECODE screen in the RTTY mode.

**MENU** » **DECODE**

**TIP:** Touching [EXPD/SET] toggles between the Normal screen and Expanded screen.



Normal screen

RTTY DECODE screen

When tuned to an RTTY signal, the decoded characters are displayed.



Expanded screen

RTTY DECODE screen

Key	Action	
<1>	Selects the function menu.	
<2>	Selects the function menu.	
HOLD	Turns the Hold function ON or OFF. ① "HOLD" is displayed, and the RTTY DECODE screen stops.	
CLR	Touch for 1 second to clear the displayed characters. • While the Hold function is ON, this clears the characters and cancels the Hold function.	
TX MEM	Opens the RTTY MEMORY screen.	
LOG	Opens the RTTY DECODE LOG screen. • Starts/Stops logging, selects the file type or the time stamp.	
LOG VIEW	Opens the RTTY DECODE LOG VIEW screen. • You can check the saved RTTY log files.	
ADJ	Opens the THRESHOLD screen. • You can set the threshold level.	
EXPD/SET	Touch	Selects the Expanded or Normal screen.
	Touch for 1 second	Opens the RTTY DECODE SET screen.

◆ Setting the decoder threshold level

Adjusting the RTTY decoder threshold level prevents characters been decoded by noise, even though you have not received an RTTY signal.

1. Open the RTTY DECODE screen.

**MENU** » **DECODE**

2. Touch [<1>].

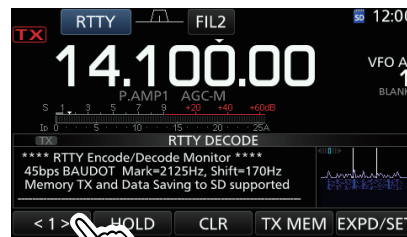

RTTY DECODE screen

- The function menu <2> is displayed.

3. Touch [ADJ].

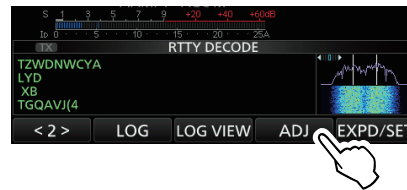

- The THRESHOLD setting screen is displayed.

4. Checking the RTTY DECODE, rotate **MAIN DIAL** to adjust the threshold level to where the characters are not displayed by noise.

① If the threshold level adjusted is too high, you cannot receive weak signals.

① Touch [DEF] for 1 second to reset to the default setting.



5. To close the THRESHOLD setting screen, touch [ADJ].



## FM repeater operation

A repeater receives your radio's signals and simultaneously retransmits them on a different frequency to provide a greater communication range. When using a repeater, the transmit frequency shifts from the receive frequency by an offset amount. You can access a repeater using the split function.

1. Select the desired operating band. (p. 3-2)  
(Example: 28 MHz band)
2. Rotate **(MAIN DIAL)** to set the operating frequency.



(Example: 29.650.00 MHz)

3. Select the FM mode.
4. Hold down **(SPLIT)** for 1 second.
  - Turns the Split function ON.
  - Turns the Tone function ON and "TONE" is displayed.
  - Displays the transmit frequency.

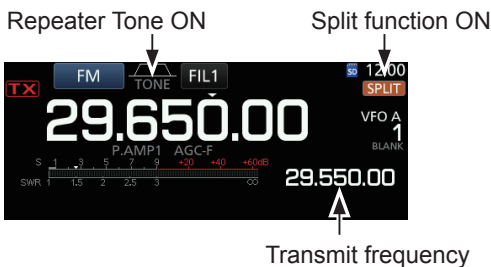

① You can set the frequency offset for the HF band. (p. 8-3)

**(MENU)** » SET > Function > SPLIT > FM SPLIT Offset (HF)

① You can set the frequency offset for the 50 MHz band. (p. 8-3)

**(MENU)** » SET > Function > SPLIT > FM SPLIT Offset (50M)

### ◇ Setting the repeater tone frequency

Some repeaters require a subaudible tone to be accessed. Subaudible tones are superimposed on your signal, and must be set in advance. Do the following steps to set the tone frequency.

1. Select the FM mode.
2. Push **(FUNCTION)**.
  - Opens the FUNCTION screen.
3. Touch [TONE] for 1 second.

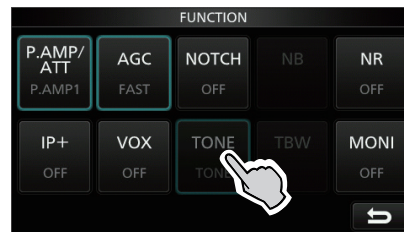

FUNCTION screen (FM mode)

4. Rotate **(MAIN DIAL)** to select the desired subaudible tone frequency.

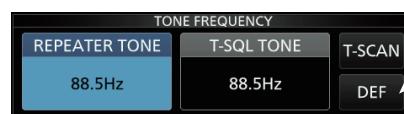

TONE FREQUENCY screen

Touch for 1 second to reset to the default.

#### • Selectable tone frequencies

67.0	88.5	114.8	151.4	177.3	203.5	250.3
69.3	91.5	118.8	156.7	179.9	206.5	254.1
71.9	94.8	123.0	159.8	183.5	210.7	
74.4	97.4	127.3	162.2	186.2	218.1	
77.0	100.0	131.8	165.5	189.9	225.7	
79.7	103.5	136.5	167.9	192.8	229.1	
82.5	107.2	141.3	171.3	196.6	233.6	
85.4	110.9	146.2	173.8	199.5	241.8	

### Checking the repeater tone frequency

You can check the tone frequency by receiving the repeater's input frequency and tone scanning. To receive the input signals, the transceiver detects the subaudible tone frequency using the tone scan function.

1. Touch [T-SCAN].
  - The scan starts, and then stops when the matching tone frequency as the repeater is received.



2. To close the TONE FREQUENCY screen, push **(EXIT)**.

### Spectrum scope screen

This spectrum scope enables you to display the activity on the selected band, as well as the relative strengths of various signals.

The IC-7300 has two spectrum scope modes. One is the Center mode, and another one is the Fixed mode. You can also turn the Waterfall display ON or OFF. In addition, you can select a Mini scope screen to save screen space.

#### Center mode screen

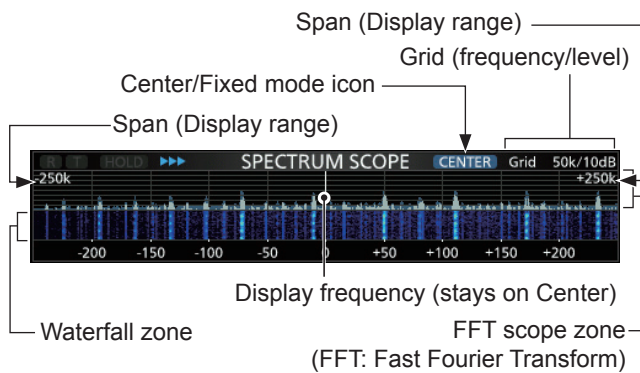

#### Fixed mode screen

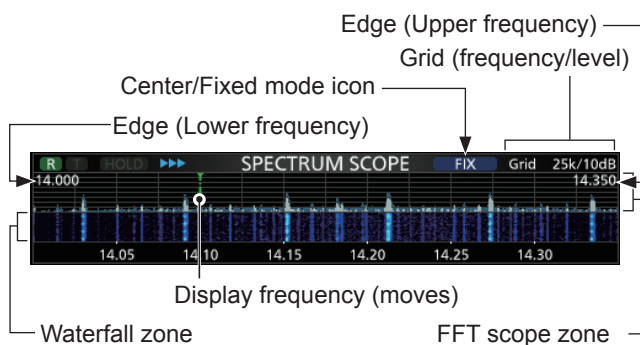

#### Using the Spectrum Scope

- Open the SPECTRUM SCOPE screen.

**MENU** » **SCOPE**

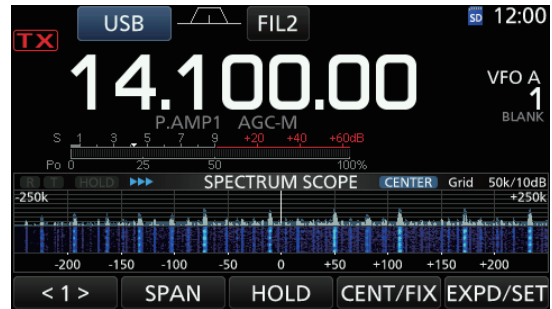

SPECTRUM SCOPE screen



Function menu (Menu 2)

Key	Action	
< 1 > < 2 >	Selects the Function menus.	
SPAN	In the Center mode, selects the scope span. • Selectable spans: $\pm 2.5$ , 5.0, 10, 25, 50, 100, 250 and 500 kHz ① Touch for 1 second to select the $\pm 2.5$ kHz span.	
EDGE	In the Fixed mode, selects the Edge frequencies. ① You can set the Upper and lower Edge frequencies in the SCOPE SET screen.	
HOLD	Touch	Sets the Hold function to ON or OFF. • “(HOLD)” and the Marker are displayed. Freezes the current spectrum.
	Touch for 1 second	Clears the Peak Hold level.
CENT/FIX	Selects the Center or Fixed mode.	
EXPD/SET	Touch	Selects the Expanded or Normal screen.
	Touch for 1 second	Enters the SCOPE SET screen.
REF	Opens the Reference level window. ① Touch again to close the window. ① Rotate <b>(MAIN DIAL)</b> to adjust the Reference level.	
SPEED	Selects the sweep speed. • “>>>”, “>>”, or “>” displays FAST, MID, or SLOW.	
MARKER	Selects the Marker.	

- To exit the SPECTRUM SCOPE screen, push **EXIT**.

## Spectrum scope screen (Continue)

## ◇ Center mode

Displays signals around the operating frequency within the selected span. The operating frequency is always displayed in the center of the screen.

1. Open the SPECTRUM SCOPE screen.

**MENU** » **SCOPE**

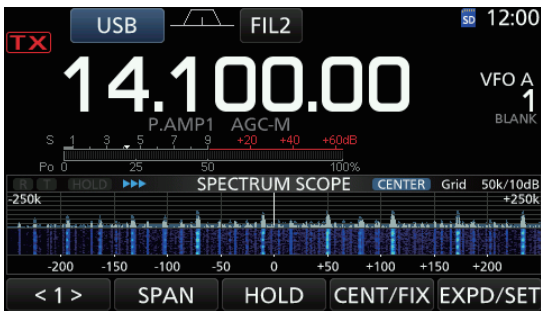

Center mode screen

2. Touch [CENT/FIX].
  - “**CENTER**” is displayed when the Center mode is selected.
  - ① Touch [CENT/FIX] to toggle between the Center and Fixed modes.
3. Touch [SPAN] several times to select the scope span.
  - Selectable span:  $\pm 2.5$ , 5.0, 10, 25, 50, 100, 250 and 500 kHz
  - ① Touch [SPAN] for 1 second to select the  $\pm 2.5$  kHz span.
4. To exit the SPECTRUM SCOPE screen, push **EXIT**.

## ◇ Fixed mode

Displays signals within a specified frequency range. The selected frequency band activity can easily be observed this mode.

Three Fixed Edge bands can be set for each amateur frequency band covered by the transceiver in the SCOPE SET screen.

1. Open the SPECTRUM SCOPE screen.

**MENU** » **SCOPE**

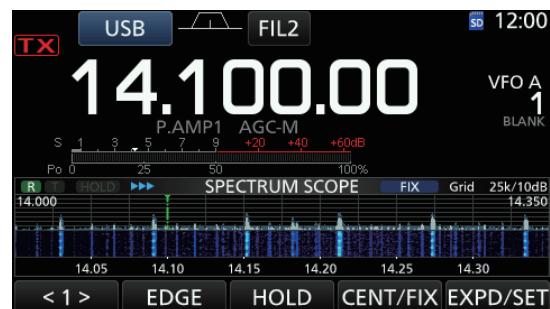

Fixed mode screen

2. Touch [CENT/FIX].
  - “**FIX**” is displayed when the Fixed mode is selected.
  - ① Touch [CENT/FIX] to toggle between the Center and Fixed modes.
3. Touch [EDGE] several times to select the Edge frequency.
  - ① When the operating frequency moves outside the upper or lower Edge frequency, “<<” or “>>” is displayed in the upper side corners of the SPECTRUM SCOPE screen.
    - <<: The frequency is outside the lower edge.
    - >>: The frequency is outside the higher edge.
 When the frequency goes further away, “Scope Out of Range” is displayed.
4. To exit the SPECTRUM SCOPE screen, push **EXIT**.

## ◇ Marker

The Marker displays the operating frequency in the SPECTRUM SCOPE screen.

## • Marker types

**R**: RX marker displays the receive frequency.

**T**: TX marker displays the transmit frequency.

Touch [MARKER] to select the marker.

- When the Center mode is selected: TX, Marker OFF
  - When the Fixed mode is selected: RX/TX, RX
- ① When the Marker is displayed and the frequency is out of range, “<<” or “>>” is displayed in the upper side corners of the SPECTRUM SCOPE screen.
    - <<: The frequency is outside the lower edge.
    - >>: The frequency is outside the higher edge.

## • About RX Marker

In the Fixed mode, the RX Marker displays the operating frequency within a specified frequency range. So, the transceiver always displays the RX marker in the scope screen.

In the Center mode, the operating frequency stays on the Center of the screen. Thus, the transceiver does not display the RX Marker.

- ① When the Hold function is ON, the RX Marker is displayed to display the operating frequency's position.

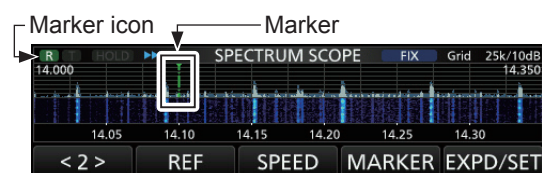

RX Marker ON (Fixed mode)

**Spectrum scope screen (Continue)**

**◇ Touch screen operation**

When you touch the FFT scope zone or the waterfall zone in the SPECTRUM SCOPE screen, the area will be zoomed up. Then you touch the signal in the zoomed area, you can directly tune your frequency to the signal in the SPECTRUM SCOPE screen.

① Holding down **[XFC]** changes the transmit frequency.

1. Open the SPECTRUM SCOPE screen.



2. Touch the Scope screen.

- Around the touched area is zoomed up.

① Touch only the FFT scope zone or Waterfall zone.

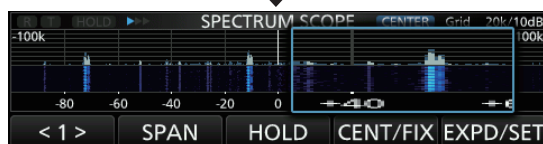
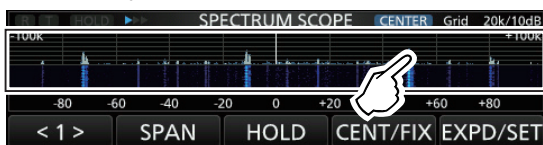

3. Touch the signal in the zoomed area.

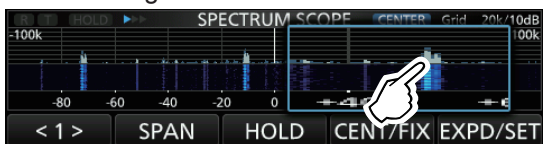

**① Information**

- In the Center mode, the operating frequency changes to the touched point, and the point moves to the screen center.
- In the Fixed mode, the operating frequency and marker change to the touched point.
- Touch out of the zoomed area to close the zoomed window.

**◇ Mini scope screen**

The Mini scope screen can be simultaneously displayed with another function displays, such as the RTTY DECODE screen and the AUDIO SCOPE screen.

Push **[M.SCOPE]** to turn the Mini scope screen ON or OFF.

① Hold down **[M.SCOPE]** for 1 second to display the SPECTRUM SCOPE screen.

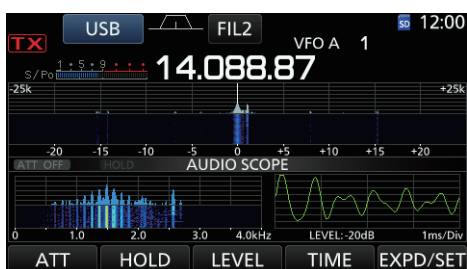

Mini scope screen with the AUDIO SCOPE screen

**Audio scope screen**

This audio scope enables you to display the received signal's frequency component on the FFT scope, and its waveform components on the Oscilloscope. The FFT scope also has an waterfall.

1. Open the AUDIO SCOPE screen.



AUDIO SCOPE screen

Key	Action	
ATT	Touch	Selects the attenuator for the FFT scope. • 0 (OFF), 10, 20, or 30 dB
	Touch for 1 second	Turns OFF the attenuator. (0 dB)
HOLD	Sets the Hold function to ON or OFF. • “[HOLD]” is displayed and freezes the current audio spectrum.	
LEVEL	Selects the Oscilloscope level. • 0, -10, -20, or -30 dB	
TIME	Selects the Oscilloscope sweep time. • 1, 3, 10, 30, 100, or 300 ms/Div	
EXPD/SET	Touch	Selects the Expanded or Normal screen.
	Touch for 1 second	Enters the AUDIO SCOPE SET screen.

2. To exit the AUDIO SCOPE screen, push **[EXIT]**.

**• AUDIO SCOPE screen**

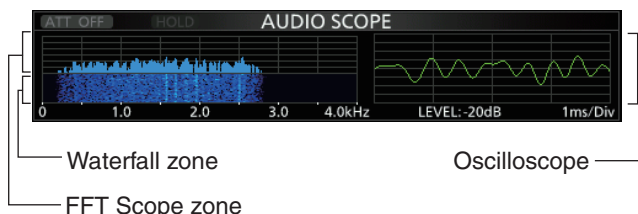

## About the SD card

The SD and SDHC cards are not supplied by Icom. User supplied.

You can use an SD card of up to 2 GB, or an SDHC of up to 32 GB.

Icom has checked the compatibility with the following SD and SDHC cards.

(As of February 2016)

Brand	Type	Memory size
SanDisk®	SD	2 GB
	SDHC	4 GB
		8 GB
		16 GB
		32 GB

- ① The above list does not guarantee the card's performance.
- ① Throughout the rest of this document, the SD card and an SDHC card are simply called the SD card or the card.

**TIP:** Icom recommends that you save the transceiver's factory default data for backup. (p. 8-7)

### NOTE:

- Before using the SD card, thoroughly read the card's instructions.
- If you do any of the following, the card data may be corrupted or deleted.
  - You remove the card from the transceiver while the card is being accessed.
  - A power failure occurs or the power cable is disconnected while the card is being accessed.
  - You drop, impact or vibrate the card.
- Do not touch the contacts of the card.
- The transceiver takes a longer time to recognize a high capacity card.
- The card will get warm if continuously used for a long period of time.
- The card has a certain lifetime, so data reading or writing may not be possible after using it for a long period. When reading or writing data is impossible, the card's lifetime has ended. In that case, use a new one. We recommend you make a separate backup file of the important data onto your PC. (p. 8-7)
- Icom will not be responsible for any damage caused by data corruption of a card.

## Saving data onto the SD card

You can save the following data onto the card:

- Data settings of the transceiver  
Memory channel contents saved in the transceiver.
- Communication contents  
The transmitted and received audio.
- Communication log  
The communication and receive history log.
- Voice audio for the Voice TX function  
Voice audio to use with the Voice TX function.
- RTTY decode log  
The transmitted or received RTTY decode history log.
- Captured screens

## Inserting or removing the SD card

**NOTE:** Format all SD cards to be used with the transceiver with the built-in Format function. Format, even preformatted cards for PCs or other uses. (p. 6-2)

### ◇ Inserting

Insert the card into the slot until it locks in place, and makes a 'click' sound.

- Displays the SD card icon when the SD card is inserted.
- ① Be sure to check the card orientation.

### ◇ Removing

Push in the SD card until a click sounds.

- The card is unlocked, and you can pull it out.
- ① If you remove the SD card while the transceiver's power is ON, be sure to unmount it. (p. 6-2)

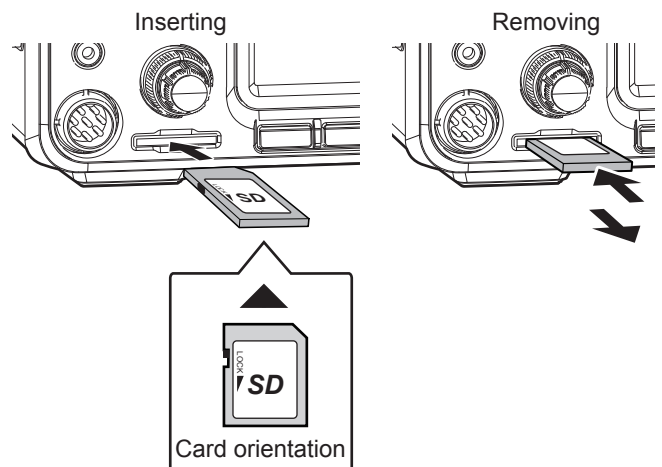



## Unmounting an SD card

Before you remove a card when the transceiver is ON, be sure to electrically unmount it, as shown below. Otherwise the data may be corrupted or deleted.

1. Open the SD CARD set screen.

**MENU** » **SET > SD Card**

2. Select “Unmount.”



SD CARD set screen

3. Touch [YES] to unmount.  
 Ⓜ To cancel unmounting, touch [NO].

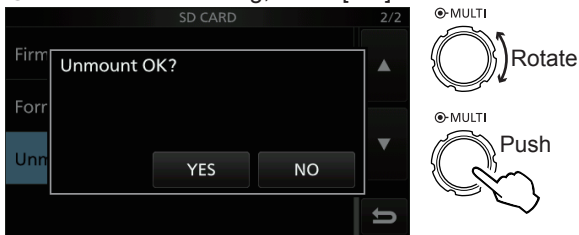

• After unmounting, returns to the SD CARD set screen.

4. To close the SET screen, push **EXIT** several times.
5. Remove the card from the transceiver.

## Formatting an SD card

Before using an SD card with the transceiver, be sure to format all SD cards with the built-in Format function. This creates a special folder on the card that you need for operations like updating the firmware. Format all cards, including a brand new SD card, and even preformatted cards for PCs or other uses.

**NOTE:** Formatting a card erases all its data. Before formatting any used card, back up its data onto your PC. (p. 8-7)

**IMPORTANT:** Even if you format an SD card, some data may remain in the card. When you dispose the card, be sure to physically destroy it to avoid unauthorized access to any data that remains.

1. Insert an SD card into the card slot.
2. Open the SD CARD set screen.

**MENU** » **SET > SD Card**

3. Select “Format.”



SD CARD set screen

4. Touch [YES] to start formatting.  
 Ⓜ To cancel formatting, touch [NO].

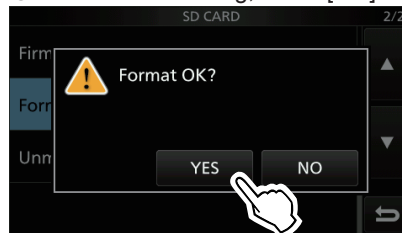

• After formatting, returns to the SD CARD set screen.

5. To close the SET screen, push **EXIT** several times.



## About the internal antenna tuner

The internal automatic antenna tuner automatically matches the transceiver to the antenna within the range of 16.7 ~ 150  $\Omega$  (SWR of less than 3:1). After the tuner matches an antenna, the latching relay combinations are memorized as a preset point for each frequency range (100 kHz steps). Therefore, when you change the frequency range, the latching relay combinations are automatically preset to the memorized point for fast tuning.

- When you install a new antenna, or you want to change the antenna settings, you can clear the all of the internal antenna tuner preset points with the “<<Preset Memory Clear>>” item on the TUNER set screen. (p. 8-3)

**MENU** » SET > Function > Tuner > <<Preset Memory Clear>>

- You can select whether or not to save the internal antenna tuner’s status after pushing **TUNER** on each band in the “[TUNER] Switch” item on the TUNER set screen. (p. 8-3)

**MENU** » SET > Function > Tuner > [TUNER] Switch

**NOTE:** When the transceiver receives a strong physical shock, the internal latching relays may be returned to an unlatched condition. In that case, push **TUNER** to turn OFF the tuner, then turn ON again to reset the all latching relays.

## Internal antenna tuner operation

1. Push **TUNER** to turn ON the internal antenna tuner.
  - “TUNE” is displayed when the tuner is ON.
2. Tune the antenna.
  - ① To tune the antenna, see “Manual tuning” or “PTT Tuner start” below.

### ◇ Manual tuning

You can manually tune the antenna before transmitting for the first time.

1. Hold down **TUNER** for 1 second to start manual tuning.
  - The tuner reduces the SWR to less than 1.5:1 after 2~3 seconds of tuning.
  - ① While tuning, a side tone is heard and “TUNE” blinks red.
2. After tuning, “TUNE” is displayed.
  - ① If the tuner cannot reduce the SWR to less than 1.5:1 after 20 seconds, tuning stops and “TUNE” goes out.

### ◇ PTT Tuner start

The tuner is always activated when PTT is pushed after the frequency is changed (more than 1% from last-tuned frequency). This function tunes the antenna for the first transmission on a new frequency.

- ① This function can be turned ON in the “PTT Start” item of the TUNER set screen. (p. 8-3)

**MENU** » SET > Function > Tuner > PTT Start

### NOTE:

- If the SWR is higher than about 1.5:1 when tuning more than 100 kHz on an antenna’s preset point, hold down **TUNER** for 1 second to start manual tuning.
- If you transmit into a high SWR, “TUNE” may blink. In that case, hold down **TUNER** for 1 second to manually tune.

### If the tuner cannot tune the antenna

- Repeat manual tuning several times.
- Even if the tuner cannot tune the antenna on the first tuning, it may success at the second tuning.
- Some antennas, especially for the low bands, have a narrow bandwidth. These antennas may not tune at the edge of their bandwidth, therefore, tune such an antenna as follows:  
(Example):  
Suppose you have an antenna which has an SWR of 1.5:1 at 3.55 MHz and an SWR of 3:1 at 3.8 MHz.
  1. Set 3.55 MHz, and hold down **TUNER** for 1 second to start manual tuning.
  2. Set 3.80 MHz, and hold down **TUNER** for 1 second to start manual tuning.

## Set mode description

You can use the Set mode to set infrequently changed values or function settings.

**TIP:** The Set mode is constructed in a tree structure. You may go to the next tree level, or go back a level, depending on the selected item.

### ◇ Entering the Set mode

1. Push **MENU**.
  - Opens the MENU screen.

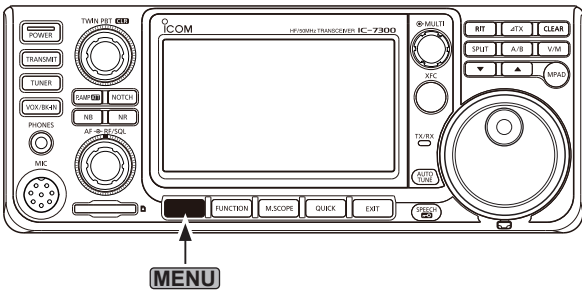

2. Touch [SET].
  - Opens the SET screen.

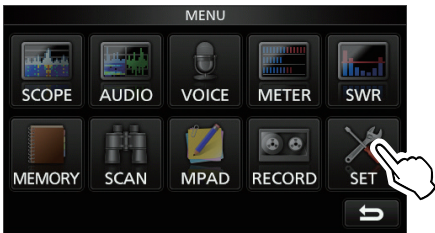

3. Rotate **(MULTI)** to select the desired item.
  - ① You can also select the item by touching [▲] or [▼] in the screen.

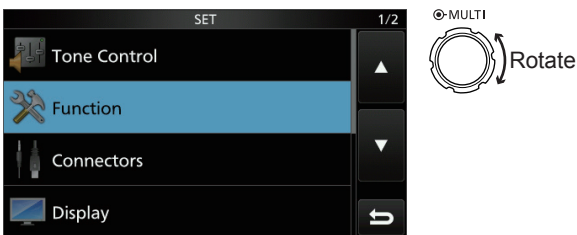

4. Push **(MULTI)** to go to the next tree level.
  - ① You can also go to the next tree level by directly touching the desired item in the screen.
5. Repeat steps 3 and 4 to open the desired item's setting screen.
  - ① To go back the previous tree level, push **EXIT**.

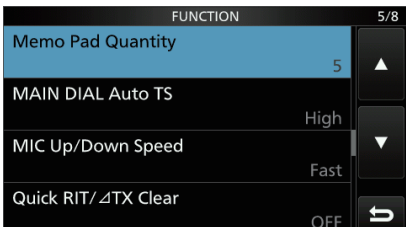

6. Rotate **(MULTI)** to select the desired option, and then push **(MULTI)** to set it.

#### ① Information

- You can also select the option by directly touching the option or [+] or [-] in the screen.
- When you continuously set other items in the same tree level, repeat step 6.
- When you continuously set other item in the different tree level, push **EXIT** to go back the previous tree level.

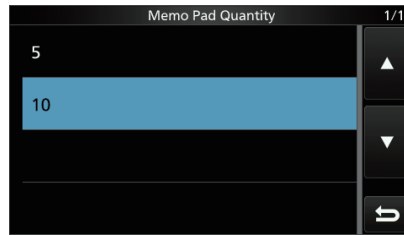

#### TIP: How to reset to the default setting

Touching the item or its option for 1 second displays the Quick menu, and then touch "Default" to reset to the default setting.

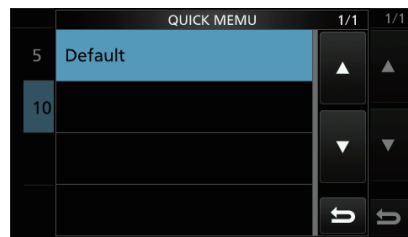

① To close the Quick menu, push **EXIT**.

7. To close the SET screen, push **EXIT** several times.

## Tone Control

### SSB RX HPF/LPF (Default: -----)

Sets the receive audio high-pass filter and low-pass filter cut-off frequencies in 100 Hz steps.

① If this item is set, the “SSB RX Bass” and “SSB RX Treble” items are automatically set to “0.”

### SSB RX Bass (Default: 0)

### SSB RX Treble (Default: 0)

Sets the bass or treble level of the receive audio.

### AM RX HPF/LPF (Default: -----)

Sets the receive audio high-pass filter or low-pass filter cut-off frequencies in 100 Hz steps.

Selectable ranges:

① If this item is set, the “AM RX Bass” and “AM RX Treble” items are automatically set to “0.”

### AM RX Bass (Default: 0)

### AM RX Treble (Default: 0)

Sets the bass or treble level of the receive audio.

### FM RX HPF/LPF (Default: -----)

Sets the receive audio high-pass filter or low-pass filter cut-off frequencies in 100 Hz steps.

① If this item is set, the “FM RX Bass” and “FM RX Treble” items are automatically set to “0.”

### FM RX Bass (Default: 0)

### FM RX Treble (Default: 0)

Sets the bass or treble level of the receive audio.

### CW RX HPF/LPF (Default: -----)

### RTTY RX HPF/LPF (Default: -----)

Sets the receive audio high-pass filter or low-pass filter cut-off frequencies in 100 Hz steps.

### SSB TX Bass (Default: 0)

### SSB TX Treble (Default: 0)

Sets the bass or treble level of the receive audio.

### SSB TBW (WIDE) (Default: 100 – 2900)

### SSB TBW (MID) (Default: 300 – 2700)

### SSB TBW (NAR) (Default: 500 – 2500)

Sets the transmission pass bandwidth to wide, mid, or narrow, by changing the lower and higher cut-off frequencies.

### AM TX Bass (Default: 0)

### AM TX Treble (Default: 0)

Sets the bass or treble level of the transmit audio.

### FM TX Bass (Default: 0)

### FM TX Treble (Default: 0)

Sets the bass or treble level of the transmit audio.

## Function

### Beep Level (Default: 50%)

Sets the beep output level.

① If the “Beep (Confirmation)” item is set to “OFF,” no beep sounds.

### Beep Level Limit (Default: ON)

Selects whether or not to limit the volume up to the specified level.

### Beep (Confirmation) (Default: ON)

Turns the Confirmation beep ON or OFF.

① If the “Beep Level” item is set to “0%,” no beep sounds.

### Band Edge Beep (Default: ON (Default))

Turns the Band Edge beep ON or OFF.

#### ① Information

- If the “Beep Level” item is set to “0%,” no beep sounds.
- When you tune into an amateur band’s frequency range, the Band Edge high beep sounds.
- When you tune out of an amateur band’s frequency range, the Band Edge low beep sounds.

### RF/SQL Control (Default: RF+SQL)

Set the **[AF/RF/SQL]** (outer) control operation.

### MF Band ATT (Default: ON)

Turns the MF Band Attenuator function ON or OFF. This function adds approximately 16 dB of attenuation to prevent a desired signal from becoming distorted when very strong MF band signals are received.

This function is usable when the frequency is set to between 0.03000 and 1.59999 MHz, for only receiving.

① When you receive a weak signal on the MF band, select “OFF.”

① The 16 dB of the MF band attenuation is added to any other attenuation value that you have set.

### TX Delay HF (Default: OFF)

### TX Delay 50M (Default: OFF)

### TX Delay 70M\* (Default: OFF)

Sets the TX delay time on the HF, 50 or 70 MHz band.

① If an external equipment’s rise time is slower than that of the IC-7300, a reflected wave is produced and it may damage the IC-7300. To prevent this, set the appropriate delay time so that no reflected wave is produced.

① Select “OFF” for no rise speed.

\*Depending on the transceiver’s version, this item may not be displayed.

### Time-Out Timer (CI-V) (Default: OFF)

Sets the Time-out Timer for CI-V operation.

This setting is valid only transmitting initiated by a CI-V command or pushing **[TRANSMIT]**.

① Select “OFF” for no time limit.

### Quick SPLIT (Default: ON)

Turns the Quick Split function ON or OFF.

### FM SPLIT Offset (HF) (Default: -0.100 MHz)

### FM SPLIT Offset (50M) (Default: -0.500 MHz)

Sets the frequency offset for the Split function in the FM mode on the HF or 50 MHz band.

### SPLIT LOCK (Default: OFF)

Turns the Split Lock function ON or OFF.

### [TUNER] Switch (Default: Auto)

Selects whether or not to save the internal antenna tuner’s status after pushing **[TUNER]** on each band.

### PTT Start (Default: OFF)

Turns the PTT Start Tuning function ON or OFF.

### <<Preset Memory Clear>>

Clears the all of the internal antenna tuner preset points.

### RTTY Mark Frequency (Default: 2125)

Selects the RTTY mark frequency.

① When the internal RTTY decoder is used, 2125 Hz is automatically selected.

### RTTY Shift Width (Default: 170)

Selects the RTTY shift width.

① When the internal RTTY decoder is used, 170 Hz is automatically selected.

### RTTY Keying Polarity (Default: Normal)

Selects the RTTY keying polarity.

### SPEECH Language (Default: English)

Selects the speech language.

### SPEECH Speed (Default: Fast)

Selects the speech speed.

## Function (Continued)

**S-Level SPEECH** (Default: ON)

Turns the S-meter level announcement ON or OFF.

**MODE SPEECH** (Default: OFF)

Turns the operating mode announcement ON or OFF.

**SPEECH Level** (Default: 50%)





Sets the Voice Synthesizer audio output level.

**[SPEECH/LOCK] Switch** (Default: SPEECH/LOCK)

Selects  action.

**Lock Function** (Default: MAIN DIAL)



This function electronically locks  or the panel display\* to prevent setting changes by accidental operation.

\*Keys and dials are also locked except for , , , and .

**Memo Pad Quantity** (Default: 5)

Sets the number of memo pad channels.

**MAIN DIAL Auto TS** (Default: High)

Sets the Auto Tuning Step function for . When rapidly rotating , the tuning step is automatically changed according to the rotation speed.

**MIC Up/Down Speed** (Default: Fast)

Sets the response speed of [▲]/[▼] on the supplied microphone while holding down.

**Quick RIT/ΔTX Clear** (Default: OFF)

Selects the operation of  for the RIT and ΔTX functions.

**[NOTCH] Switch (SSB)** (Default: Auto/Manual)**[NOTCH] Switch (AM)** (Default: Auto/Manual)

Selects the notch function used in the SSB or AM mode.

**SSB/CW Synchronous Tuning** (Default: OFF)

Turns the Displayed Frequency Shift function ON or OFF.

This function automatically shifts the frequency to match the CW pitch when the operating mode is toggled between SSB and CW.

**CW Normal Side** (Default: LSB)

Selects the carrier point in the CW normal mode.

**Screen Capture [POWER] SW** (Default: OFF)

Assigns the Screen Capture function to .

**Screen Capture File Type** (Default: PNG)

Selects the file format for the Screen Capture function.

**Keyboard Type** (Default: Full Keyboard)

Sets the keyboard entry type to Ten-Key or Full Keyboard.

**Calibration Marker** (Default: OFF)

Turns the reference frequency calibration marker ON or OFF.

**REF Adjust**

Adjusts the internal reference frequency.

**NOTE:** The default setting of "RF Adjust" may differ slightly, depending on the transceiver's version.

## Connectors

### ACC/USB Output Select (Default: AF)

Selects the signal output from [ACC] and [USB].

### ACC/USB AF Output Level (Default: 50%)

Sets the AF output level of [ACC] and [USB].

### ACC/USB AF SQL (Default: OFF (OPEN))

Selects whether or not to output the audio from [ACC] and [USB], according to the squelch state.

The same audio signals are output from [USB] and [ACC].

### ACC/USB AF Beep/Speech... Output (Default: OFF)

Sets the Beep and Speech audio output condition of [ACC] and [USB].

① You should set the “ACC/USB AF SQL” item to “AF.”

① The beep level is limited when the “Beep Level Limit” item is “ON.”

### ACC/USB IF Output Level (Default: 50%)

Sets the IF output level of [ACC] and [USB].

### ACC MOD Level (Default: 50%)

Sets the modulation input level of [ACC].

### USB MOD Level (Default: 50%)

Sets the modulation input level of [USB].

### DATA OFF MOD (Default: MIC,ACC)

Selects the connector(s) to input the modulation signal when the data mode is OFF.

### DATA MOD (Default: ACC)

Selects the connector(s) to input the modulation signal when the data mode is ON.

### External Keypad VOICE (Default: OFF)

Enables voice memory transmission using an external keypad.

### External Keypad KEYER (Default: OFF)

Enables keyer memory transmission using an external keypad.

### External Keypad RTTY (Default: OFF)

Enables RTTY memory transmission using an external keypad.

### CI-V Baud Rate (Default: Auto)

Selects the CI-V data transfer rate.

① When “Auto” is selected, the baud rate is automatically set according to the data rate of the connected controller.

### CI-V Address (Default: 94h)

Selects the CI-V address.

① “94h” is the default address of IC-7300.

### CI-V Transceive (Default: ON)

Turns the Transceive function ON or OFF.

### CI-V USB→REMOTE Transceive Address (Default: 00h)

Sets the address used to remotely control the transceiver or receiver using the optional RS-BA1, through the [USB] port.

The external equipment control signal is output from the [REMOTE] port.

### CI-V Output (for ANT) (Default: OFF)

Enables outputting the antenna controller status (frequency and so on) from the [REMOTE] port.

① Address “01h” is reserved.

The usable addresses are limited to 02h ~ DFh.

### CI-V USB Port (Default: Link to [REMOTE])

Selects the internal connection type between the [USB] and [REMOTE] CI-V ports.

### CI-V USB Baud Rate (Default: Auto)

Selects the CI-V data transfer rate when remotely controlling the IC-7300 through the [USB] CI-V port.

① When “Auto” is selected, the baud rate is automatically set according to the data rate of external controller.

① This setting is valid only when the “CI-V USB Port” item is set to “Unlink from [REMOTE].”

### CI-V USB Echo Back (Default: OFF)

Turns the Data Echo Back function ON or OFF, when remotely controlling the IC-7300 through the [USB] CI-V port.

① This setting is valid only when the “CI-V USB Port” item is set to “Unlink from [REMOTE].”

### USB Serial Function (Default: CI-V)

Selects the signal output from [USB].



## Connectors (Continued)

**RTTY Decode Baud Rate** (Default: 9600)

Selects the data transfer rate (Baud rate) of decoded RTTY signals.

**USB SEND** (Default: OFF)

You can control transmit and receive from the PC through the USB port.

Selects the control port to be used for communication between the IC-7300 and PC, according to the operating condition.

① You cannot select the terminal which is already selected in the “USB Keying (CW)” or “USB Keying (RTTY)” item.

**USB Keying (CW)** (Default: OFF)

You can control transmit, receive and keying from the PC, through the USB port.

Selects the control port to be used for communication between the IC-7300 and PC, according to the operating condition.

① You cannot select the terminal which is already selected in the “USB SEND” or “USB Keying (RTTY)” item.

**USB Keying (RTTY)** (Default: OFF)

You can control transmit, receive and RTTY (FSK) from the PC, through the USB port.

Selects the control port to be used for communication between the IC-7300 and PC according to the operating condition.

① You cannot select the terminal which is already selected in the “USB SEND” or “USB Keying (CW)” item.

## Display

**LCD Backlight** (Default: 50%)

Sets the LCD backlight brightness.

**Display Type** (Default: A)

Sets the display type to A or B.

**Display Font** (Default: Basic)

Selects the font for the frequency readout.

**Meter Peak Hold** (Default: ON)

Turns the Meter peak hold function ON or OFF.

**Memory Name** (Default: ON)

Turns the Memory name display in the Memory mode ON or OFF.

**MN-Q Popup (MN OFF→ON)** (Default: ON)

Selects whether or not to display the Manual Notch filter width when you select the Manual Notch.

**BW Popup (PBT)** (Default: ON)

Selects whether or not to display the PBT shift value while rotating **TWIN PBT CLR**.

**BW Popup (FIL)** (Default: ON)

Selects whether or not to display the IF filter width and shift value when you switch the IF filter by touching the filter icon.

**Screen Saver** (Default: 60min)

Sets the Screen Saver function.

This function activates when no operation is performed for a preset period of time.

**Opening Message** (Default: ON)

Selects whether or not to display the opening message at power ON.

**My Call**

Displays text as the opening message, up to 10 characters.

**Power ON Check** (Default: ON)

Selects whether or not to display the RF Power level at power ON.

**Display Language** (Default: English)

Sets the display language.

## Time Set

**Date** (Default: 2000/01/01)

Sets the date (Year/Month/Day).  
(The day of the week is automatically set.)

**Time** (Default: 0:00)

Sets the current time.  
(The time is displayed in the 24 hour format.)

**UTC Offset** (Default: ± 0:00)

Sets the UTC offset time.

## SD Card

**Load Setting**

Selects the saved data file to load.

**Save Setting**

Saves the setting data onto an SD card.

**SD Card Info**

Displays the SD card capacity and the time remaining for voice recording.

**Screen Capture View**

Displays the selected screen capture.

**Firmware Update**

Displays the Firmware Update mode.

**Format**

Formats the SD card.  
If you use a brand new SD card, be sure to format it.

**Unmount**

Unmounts the SD card.  
Before you remove a card when the transceiver is ON, be sure to electrically unmount it.  
Otherwise the data may be corrupted or deleted.

## Others

**Version**

Displays the transceiver firmware's version number.

**Touch Screen Calibration**

Touch to adjust the touch screen.  
① See section 14 of the Full Manual for details.

**Partial Reset**

Resets operating settings to their default values (VFO frequency, VFO settings, menu contents) without clearing the items below:

- Memory channel contents
- MY Call
- Memory Keyer
- RTTY memory
- User Band Edge
- REF Adjust
- Fixed Edges

① See "Resetting" (p. 9-1) for details.

**All Reset**

Clears all data and returns all settings to their factory defaults.

Memory channel contents, filter setting and so on will all be cleared, so you will need to rewrite your operating settings.

① See "Resetting" (p. 9-1) for details.

**Emergency**

Sets the Emergency function.

① See section 11 of the Full Manual for details.

## Resetting

Occasionally, erroneous information may be displayed. This may be caused by static electricity or by other factors.

If this problem occurs, turn OFF the transceiver. After waiting a few seconds, turn ON the transceiver.

If the problem still exists, perform a Partial reset as described to the right.

If the problem still exists after a Partial reset, perform an All reset as described to the right.

**NOTE:** An All reset clears all data and returns all settings to their factory defaults. Save memory channel content, setting status, and so on, onto an SD card before the All reset. (p. 6-1)

### After performing the partial reset

A Partial reset resets operating settings to their default values (VFO frequency, VFO settings, menu contents) without clearing the items listed below:

- Memory channel contents
- MY Call
- Memory Keyer
- RTTY memory
- User Band Edge
- REF Adjust
- Fixed Edges

### After performing the All reset

All reset clears all data and returns all settings to their factory defaults.

Memory channel contents, filter setting and so on will all be cleared, so you will need to rewrite your operating settings, unless you have a backup.

### When you cannot enter the Set mode

If a touch screen operation error or an unexpected operation occurs, you cannot enter the Set mode. In this case, perform the All reset as described below:

While holding down **CLEAR** and **V/M**, push **POWER**.

### ◇ Partial reset

1. Open the RESET screen.  
**MENU** » **SET > Others > Reset**
2. Touch “Partial reset.”  
 • The confirmation screen is displayed.



3. Touch [Yes].  
 ① After the resetting, the default VFO mode screen is displayed.

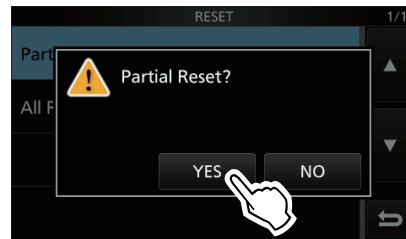

### ◇ All reset

1. Open the RESET screen.  
**MENU** » **SET > Others > Reset**
2. Touch “All reset.”  
 • The confirmation screen is displayed.



3. Touch [NEXT].



4. After carefully reading the displayed message, touch [YES] to perform the All reset.  
 ① After the resetting, the default VFO mode screen is displayed.

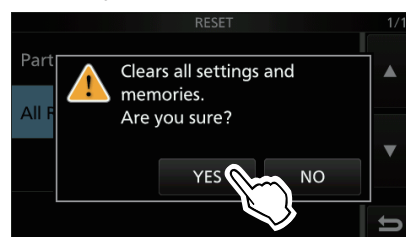

# 10 SPECIFICATIONS

## ◇ General

- Frequency coverage (unit: MHz):

Receiver	0.030000~74.800000* <sup>1</sup>
Transmitter	1.800000~ 1.999999* <sup>2</sup>
	3.500000~ 3.999999* <sup>2</sup>
	5.255000~ 5.405000* <sup>2</sup>
	7.000000~ 7.300000* <sup>2</sup>
	10.100000~10.150000* <sup>2</sup>
	14.000000~14.350000* <sup>2</sup>
	18.068000~18.168000* <sup>2</sup>
	21.000000~21.450000* <sup>2</sup>
	24.890000~24.990000* <sup>2</sup>
	28.000000~29.700000* <sup>2</sup>
	50.000000~54.000000* <sup>2</sup>
	70.000000~70.500000* <sup>2</sup>

\*<sup>1</sup> Some frequency ranges are not guaranteed.

\*<sup>2</sup> Depending on the transceiver version.

- Operating modes: USB/LSB (J3E), CW (A1A), RTTY (F1B), AM (A3E) and FM (F3E)
- Number of memory channels: 101 (including 2 scan edges)
- Antenna connector: SO-239 (antenna impedance: 50 Ω)
- Power supply requirement: 13.8 V DC (±15%)
- Operating temperature range: -10°C to +60°C, +14°F to +140°F
- Frequency stability: Less than ±0.5 ppm (-10°C to +60°C, +14°F to +140°F)
- Frequency resolution: 1 Hz (minimum)
- Power consumption:
 

Receive	Standby	0.9 A
	Maximum audio	1.25 A
Transmit	Maximum power	21.0 A
- Dimensions (projections not included): 240 (W)×94 (H)×238 (D) mm, 9.4 (W)×3.7 (H)×9.4 (D) in
- Weight (approximately): 4.2 kg, 9.3 lb

## ◇ Transmitter

- Transmit output power:
 

HF and 50 MHz bands	
SSB/CW/RTTY/FM	2~100 W
AM	1~25 W
70 MHz band* <sup>2</sup>	
SSB/CW/RTTY/FM	2~50 W
AM	1~12.5 W

\*<sup>2</sup> Depending on the transceiver version.
- Modulation system:
 

SSB	P.S.N. modulation
AM	Low power modulation
FM	Reactance modulation
- Spurious emission:
 

Harmonics	Less than -50 dB (1.8~28 MHz)
	Less than -63 dB (50 MHz band)
	Less than -60 dB (70 MHz band)
Out-of-band emission	Less than -40 dB (1.8~28 MHz)
	Less than -60 dB (50 MHz band)
	Less than -60 dB (70 MHz band)
- Carrier suppression: More than 50 dB
- Unwanted sideband suppression: More than 50 dB
- Microphone impedance: 600 Ω

### ◇ Receiver

• Receive system:	Direct sampling superheterodyne
• Intermediate frequency:	36 kHz
• Sensitivity (Filter: SOFT):	
SSB/CW (at 10 dB S/N)	
1.8 ~ 29.999999 MHz	Less than -123 dBm (0.16 $\mu$ V) (P.AMP1 ON)
50 MHz band	Less than -125 dBm (0.13 $\mu$ V) (P.AMP2 ON)
70 MHz band* <sup>2</sup>	Less than -123 dBm (0.16 $\mu$ V) (P.AMP2 ON)
	* <sup>2</sup> Depending on the transceiver version.
AM (at 10 dB S/N)	
0.5 ~ 1.8 MHz	Less than -85 dBm (12.6 $\mu$ V) (P.AMP1 ON)
1.8 ~ 29.999999 MHz	Less than -101 dBm (2.0 $\mu$ V) (P.AMP1 ON)
50 MHz and 70 MHz bands	Less than -107 dBm (1.0 $\mu$ V) (P.AMP2 ON)
FM (at 12 dB SINAD)	
28.0 ~ 29.7 MHz	Less than -113 dBm (0.5 $\mu$ V) (P.AMP1 ON)
50 MHz and 70 MHz bands	Less than -119 dBm (0.25 $\mu$ V) (P.AMP2 ON)
• Squelch sensitivity (threshold):	
SSB	Less than -92 dBm (5.6 $\mu$ V)
FM	Less than -117 dBm (0.3 $\mu$ V)
	(HF band: P.AMP1 ON, 50 MHz band: P.AMP2 ON)
• Selectivity (Filter: SHARP):	
SSB (BW=2.4 kHz)	More than 2.4 kHz/-6 dB Less than 3.4 kHz/-40 dB
CW (BW=500 Hz)	More than 500 Hz/-6 dB Less than 700 Hz/-40 dB
RTTY (BW=500 Hz)	More than 500 Hz/-6 dB Less than 800 Hz/-40 dB
AM (BW=6 kHz)	More than 6.0 kHz/-6 dB Less than 10 kHz/-40 dB
FM (BW=15 kHz)	More than 12.0 kHz/-6 dB Less than 22 kHz/-40 dB
• Spurious and image rejection:	More than 70 dB (except for ADC aliasing)
• Audio output power:	More than 2.5 W (8 $\Omega$ load, 1 kHz, 10% distortion)
• AF output impedance:	8 $\Omega$
• RIT variable range:	$\pm$ 9.999 kHz

### ◇ Antenna tuner

• Tunable impedance range:	16.7~150 $\Omega$ (unbalanced) (less than 3:1 VSWR)
• Tuning accuracy:	Less than 1.5:1 VSWR
• Tuning time (approximately):	2~3 seconds (average) 15 seconds (maximum)

①All stated specifications are typical and subject to change without notice or obligation.

## Options

### IC-PW1/IC-PW1EURO LINEAR AMPLIFIER

HF/50 MHz all band 1 kW linear amplifier including an automatic antenna tuner. An optional OPC-599 is required for the connection.



### AH-2b

#### ANTENNA ELEMENT

A 2.5 m (8.2 ft) long antenna element for mobile operation with the AH-4.



### AH-4 ANTENNA TUNER

Automatic antenna tuner to tune a long wire antenna for base, portable, or mobile HF/50 MHz operation.



### AH-740 AUTOMATIC TUNING ANTENNA

High performance, automatic high-speed tuning antenna.

The optional AH-5NV NVIS KIT is available.



### HM-36 MICROPHONE

Hand microphone with [UP]/[DOWN] switches.



### PS-126 DC POWER SUPPLY

- Output voltage: 13.8 V DC
- Maximum output current: 25 A



### CT-17 CI-V CONVERTER

For remote transceiver control using a PC equipped with an RS-232C port.



### SM-50

#### DESKTOP MICROPHONE

Dynamic microphone with [UP]/[DOWN] switches.



### SM-30

#### DESKTOP MICROPHONE

Desktop microphone with a low frequency cut function.



### SP-23

#### EXTERNAL SPEAKER

External speaker with high and low frequency cut functions.



### SP-34

#### EXTERNAL SPEAKER

External speaker with high and low frequency cut functions.



- **AH-5NV** NVIS KIT  
Use with the AH-740.
- **AH-710** FOLDED DIPOLE ANTENNA  
Covers 2 to 30 MHz wide frequency range.  
Element length: 24.5 m (80.4 ft)  
Coaxial cable (supplied): 30 m (98.4 ft)
- **HM-219** MICROPHONE  
The same as supplied.
- **MB-118** MOUNTING BRACKET  
To mount the transceiver inside a vehicle.
- **MB-123** CARRYING HANDLE
- **OPC-420** CONTROL CABLE  
A 10 m (32.8 ft) shielded control cable for the AH-4.
- **OPC-599** ADAPTER CABLE  
13-pin ACC connector adaptor to 7-pin + 8-pin ACC connectors.

- **RS-BA1** IP REMOTE CONTROL SOFTWARE

**NOTE:** To remotely control transceivers using the RS-BA1, BE SURE to comply with your local regulations.

- **SP-33** EXTERNAL SPEAKER  
Designed for base station operation.
- **SP-35** EXTERNAL SPEAKER  
Designed for mobile operation.

Approved Icom optional equipment is designed for optimal performance when used with an Icom transceiver. Icom is not responsible for the destruction or damage to an Icom transceiver in the event the Icom transceiver is used with equipment that is not manufactured or approved by Icom.



## Mounting the MB-118

Mount the MB-118 MOUNTING BRACKET to a place where it can be firmly attached.

- ① We recommend that you periodically check whether the screws are loose or not, especially after a long period of use.

**NOTE:**

- Before mounting the MB-118, carefully read PRECAUTIONS (p. vii) and decide the mounting place.
- DO NOT use bolts other than the ones that are supplied with the MB-118. Other bolts (longer than 8 mm/0.31 in) may damage the internal units.

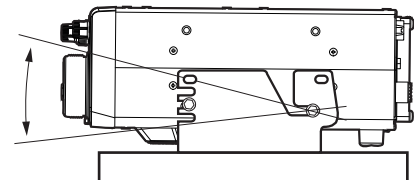
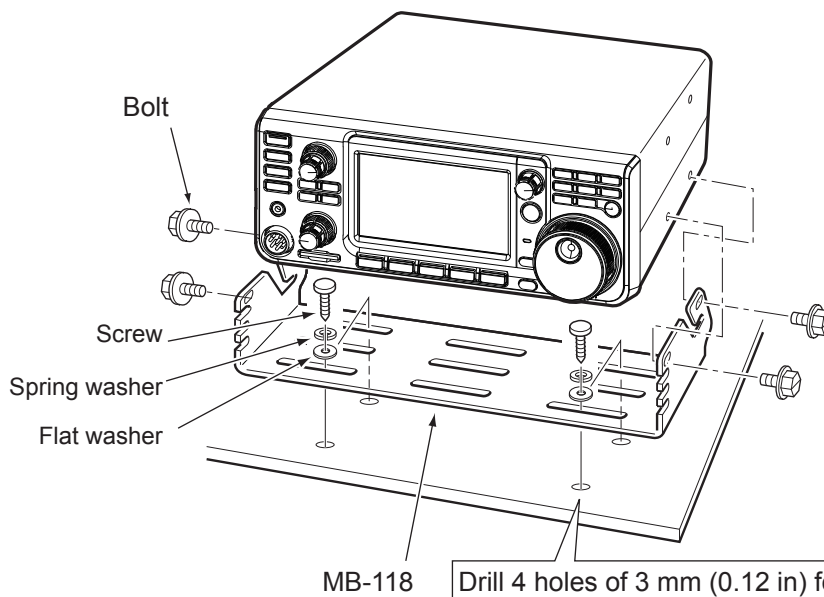

Adjust for the best viewing angle.

Drill 4 holes of 3 mm (0.12 in) for the bracket location.  
 ① Drill 5.5 mm~5.6 mm (0.21 in~0.22 in) holes when using the supplied hex screws.

# 12 CONNECTOR INFORMATION

## ACC socket

Connects to external equipment or a PC to control the external unit or to control the transceiver.

### • ACC socket

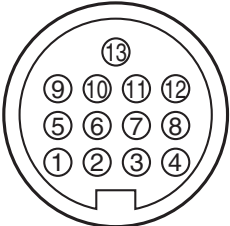
ACC	PIN No.	NAME	DESCRIPTION	SPECIFICATIONS	
 <p>Rear panel view</p> <p>① brown    ⑧ gray            ② red      ⑨ white            ③ orange   ⑩ black            ④ yellow   ⑪ pink            ⑤ green    ⑫ light blue            ⑥ blue     ⑬ light blue            ⑦ purple    ⑬ light green</p> <p>Color refers to the cable strands of the supplied cable.</p>	1	8 V	Regulated 8 V output. (Used as the reference voltage for the band voltage.)	Output voltage: 8 V $\pm$ 0.3 V Output current: Less than 10 mA	
	2	GND	Connects to ground.	—	
	3	SEND*1	Input/output pin.	An external unit controls the transceiver. When this pin goes to ground, the transceiver transmits.  The pin goes low when the transceiver transmits.	Input voltage (RX): 2.0 to 20.0 V Input voltage (TX): -0.5 to +0.8 V Current flow: Maximum 20 mA  Output voltage (TX): Less than 0.1 V Current flow: Maximum 200 mA
	4	BDT	Not used.	—	
	5	BAND	Band voltage output. (Varies with the selected amateur band)	Output voltage: 0 to 8.0 V	
	6	ALC	ALC voltage input.	Input level: -4 to 0 V Input impedance: More than 3.3 k $\Omega$	
	7	NC	—	—	
	8	13.8 V	13.8 V output when power is ON.	Output current: Maximum 1 A	
	9	TKEY	Not used.	—	
	10	FSKK	Controls RTTY keying.	High level: More than 2.4 V Low level: Less than 0.6 V Output current: Less than 2 mA	
	11	MOD	Modulator input.	Input impedance: 10 k $\Omega$ Input level: 100 mV rms*3	
	12	AF/IF (IF=12 kHz)*2	Fixed AF detector or receive IF (12 kHz) signal output.	Output impedance: 4.7 k $\Omega$ Output level: 100 ~ 300 mV rms*4	
	13	SQL S	Squelch output. Grounded when the squelch opens.	SQL open: Less than 0.3 V/5 mA SQL closed: More than 6.0 V/100 $\mu$ A	

\*1 When the SEND terminal controls an inductive load, such as a relay, a counter-electromotive force can malfunction or damage the transceiver. To prevent this, we recommend adding a switching diode, such as an 1SS133, on the load side of the circuit to absorb the counter-electromotive force. When the diode is added, a delay in relay switching may occur. Be sure to check its switching action before operating.

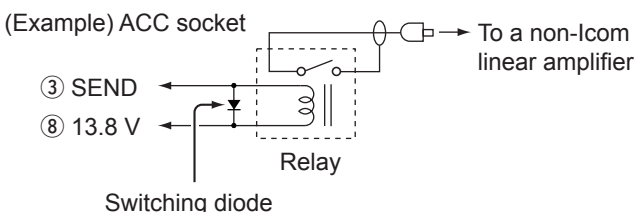

\*2 You can change the pin 12 setting in the "ACC/USB Output Select" item on the CONNECTORS set screen. If the pin is set to IF, the transceiver outputs a 12 kHz IF signal from [ACC]. In that case, you can listen to the DRM broadcast with the application software receiver that is installed into your PC.

\*3 You can change the input level in the "ACC MOD Level" item on the CONNECTORS set screen. (p. 8-5) 100 mV rms is at the 50% (default) setting.

\*4 You can change the output level in the "ACC/USB AF Output Level" item on the CONNECTORS set screen. (p. 8-5) Approximately 200 mV rms is at the 50% (default) setting.

**ACC socket (Continued)**

**◇ OPC-599 ACC conversion cable pin assignments**

The OPC-599 ACC conversion cable connects between a 13 pin [ACC] socket and 7 pin and 8 pin sockets.

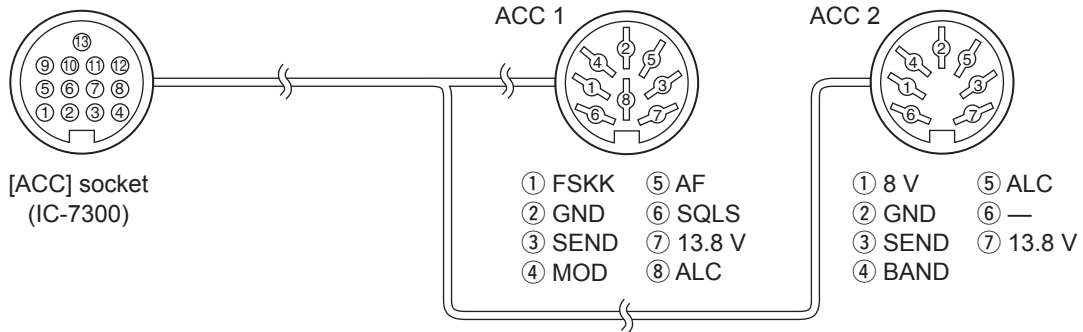

**Microphone connector**

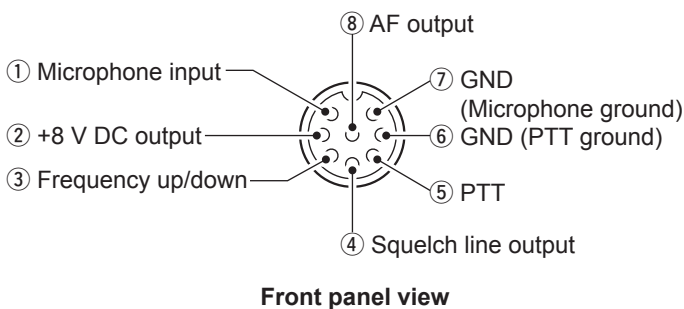

PIN No.	DESCRIPTION
①	Microphone input (Impedance: 600 Ω)
②	+8 V DC output (Maximum 10 mA)
③	Up: Ground Down: Ground through 470 Ω
④	Grounded when the squelch opens.
⑤	PTT
⑥	PTT ground
⑦	Microphone ground
⑧	AF output (varies with the [AF] control.)

12

**◇ External keypad**

A circuit is used to output memory content from 4 memories. You can output desired memory content such as that from a CW Memory keyer (M1 ~ M4), Voice memory (T1 ~ T4), RTTY Memory (RT1 ~ RT4) to be transmitted.

- Push a switch to send the memory information.
- Hold down the switch for 1 second to repeatedly send the memory information.

① To use the external keypad, turn ON the following items in the CONNECTORS set screen. (p. 8-5)

**MENU** » **SET > Connectors > External Keypad**

- VOICE: ON
- KEYER: ON
- RTTY: ON

① The External keypad is not supplied by Icom. (User supplied)

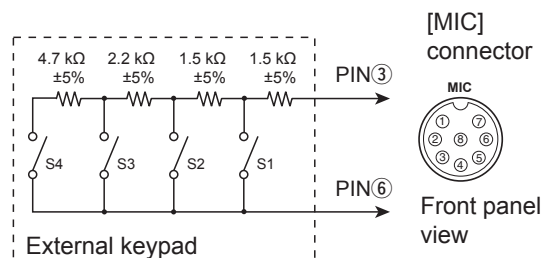

## KEY jack

Connects to a CW straight key or a paddle:  
6.35 mm (1/4 in) (d)

When connecting a CW straight key.

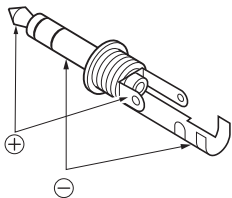

When connecting a CW paddle and using the internal electronic keyer.

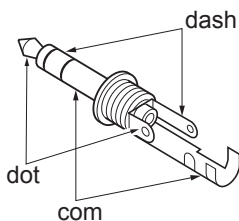

## EXT-SP jack

EXT-SP Connects to an external speaker:  
3.5 mm (1/8 in) (d)  
• Output impedance: 4 ~ 8 Ω  
• Output level: More than 2.5 W at 10% distortion into an 8 Ω load.

## REMOTE jack

REMOTE Used for computer control and transceive operation: 3.5 mm (1/8 in) (d)  
The optional CT-17 is required when connecting a PC to [REMOTE].

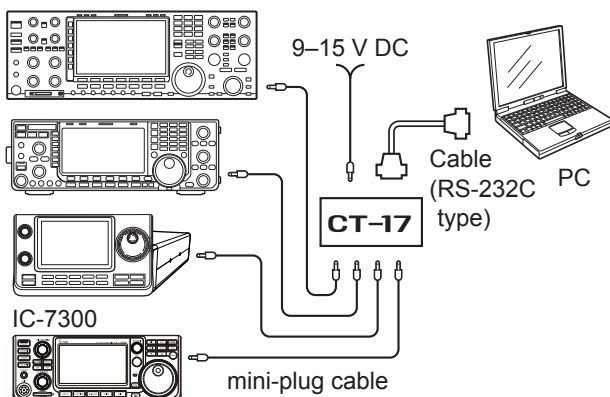

## ALC jack

ALC Connects to the ALC output jack of a non-Icom linear amplifier. (RCA Plug)  
• Control voltage: -4 ~ 0 V

## SEND jack

SEND The terminal goes low when the transceiver transmits. (RCA Plug)  
This terminal is used to control an external non-Icom linear amplifier.  
T/R control voltage and current must be less than 16 V DC and 0.5 A.

## PHONES jack

PHONES Connects to standard stereo headphones:  
3.5 mm (1/8 in) (d)  
• Output impedance: 8 ~ 16 Ω  
• Output level: More than 5 mW into an 8 Ω load.

## DC power socket

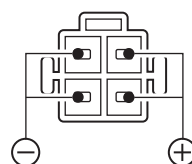

Rear panel view

Accepts the regulated DC power for 13.8 V DC ±15% through the supplied DC power cable.

**⚠ WARNING! NEVER** reverse the DC power cable polarity.

Numbers and symbols	
1 Hz step Fine Tuning function .....	3-3
1/4 Tuning function .....	3-4
5 MHz frequency band operation .....	3-11
$\Delta$ TX function .....	4-8
$\Delta$ TX monitor function .....	4-8
A	
About the instructions .....	iv
ACC socket .....	12-1
AGC function control .....	4-2
AGC time constant preset value, selecting .....	4-2
AGC time constant, setting .....	4-2
ALC jack .....	12-3
All reset .....	9-1
Antenna tuner .....	10-2
Connecting .....	2-3
Internal .....	7-1
Operation .....	7-1
Antenna tuner operation, internal .....	7-1
ANTI VOX .....	4-7
Attenuator .....	4-1
Audio scope screen .....	5-3
Auto Notch function .....	4-6
Auto Tuning Step function .....	3-4
B	
Band Edge Beep .....	3-5
Band Edge, entering .....	3-6
Band operation, 5 MHz frequency .....	3-11
Band stacking registers, using .....	3-2
Basic operation .....	3-1
Basic transmission .....	3-9
Break-in function .....	4-12
C	
CD .....	iii
CE .....	III
Center mode .....	5-2
Center mode screen .....	5-1
Characters, entering and editing .....	1-7
Connection	
Front panel .....	2-1
Rear panel .....	2-2
Connections and installation .....	2-1
Connector information .....	12-1
Connector, microphone .....	12-2
Connectors .....	8-5
CW	
Auto Tuning function .....	4-13
Operating .....	4-11
Pitch control, setting .....	4-11
Reverse mode .....	4-13
Side tone, monitoring .....	4-14
D	
DC power socket .....	12-3
Decoder threshold level, setting .....	4-16
DELAY .....	4-7
DEPTH .....	4-5
Dial Lock function .....	3-9
Display .....	8-6
Disposal .....	ii
E	
Editing	
Characters .....	1-7
Example .....	1-8
Keyboard .....	1-7
Electronic Keyer function .....	4-14
Entering	
Example .....	1-8
Characters .....	1-7
Keyboard .....	1-7
Set mode .....	8-1
Equalizing VFO A and VFO B .....	3-1
External DC power supply, connecting .....	2-3
External keypad .....	12-2
EXT-SP jack .....	12-3
F	
FCC information .....	ii
Features .....	i
Filter, Twin Peak .....	4-15
Fixed mode .....	5-2
Fixed mode screen .....	5-1
FM repeater operation .....	4-17
Formatting an SD card .....	6-2
Frequencies set to VFO A and VFO B, using .....	4-10
Frequency	
Directly entering .....	3-4
Setting .....	3-3
Front panel .....	1-1
Front panel connection .....	2-1
Function .....	8-3
FUNCTION screen .....	1-6
G	
General .....	10-1
Grounding .....	2-1
H	
Heat dissipation .....	2-1
I	
IF filter, selecting .....	4-4
IF filter shape, selecting .....	4-4
Important .....	i
Inserting the SD card .....	6-1
Installation and connections .....	2-1
Installation notes .....	III
Internal antenna tuner .....	7-1
Internal antenna tuner operation .....	7-1
IP Plus function .....	4-5
K	
KEY jack .....	12-3
Key speed, setting .....	4-12
Keyboard entering and editing .....	1-7
Keyboard types .....	1-7
Keypad, external .....	12-2
L	
Level (Noise Blanker) .....	4-5
Location, selecting .....	2-1
Lock function (dial) .....	3-9

# INDEX

M	
Main dial, using.....	3-3
Maintenance.....	9-1
Manual Notch function.....	4-6
Manual tuning.....	7-1
Marker.....	5-2
MB-118, mounting.....	11-2
Memory and VFO modes.....	3-1
MENU screen.....	1-6
Meter display.....	3-10
Meter display selection.....	3-10
Microphone connector.....	12-2
Microphone gain, adjusting.....	3-10
Mini scope screen.....	5-3
Monitor function.....	4-8
Monitoring the CW side tone.....	4-14
Multi-function menus.....	1-6
Multi-function meter.....	3-10

N	
NB level and time, adjusting.....	4-5
Noise Blanker.....	4-5
Noise Reduction	
Level, adjusting.....	4-6
Notch Filter.....	4-6
Notch function	
Auto.....	4-6
Manual.....	4-6

O	
OPC-599 ACC conversion cable pin assignments.....	12-2
Operating band, selecting.....	3-2
Operating mode, selecting.....	3-2
Options.....	11-1
Others (Set mode).....	8-7

P	
Panel description.....	1-1
Partial reset.....	9-1
PHONES jack.....	12-3
Power	
ON or OFF.....	3-1
When first applying.....	3-1
Preamplifiers.....	4-1
Precautions.....	vii
PTT Tuner start.....	7-1

Q	
QUICK MENU.....	1-6
Quick Split function, using.....	4-10

R	
Rear panel.....	1-3
Rear panel connection.....	2-2
Receiver.....	10-2
Receiving and transmitting.....	4-1
REMOTE jack.....	12-3
Removing the SD card.....	6-1
Repeater tone frequency, setting.....	4-17
Reset	
All.....	9-1
Partial.....	9-1
RF gain and SQL level.....	3-9
RIT	
Function.....	4-1
Monitor function.....	4-1
RTTY	
DECODE screen, functions.....	4-16
(FSK), operating.....	4-15
Reverse mode.....	4-15

S	
Saving data onto the SD card.....	6-1
Scope operation.....	5-1
SD card.....	6-1
Formatting.....	6-2
Saving data.....	6-1
Inserting.....	6-1
Removing.....	6-1
Set mode.....	8-7
Unmounting.....	6-2
SEND jack.....	12-3
Set mode.....	8-1
Description.....	8-1
Entering.....	8-1
Speech Compressor, setting.....	4-9
Specifications.....	10-1
Spectrum scope	
Screen.....	5-1
Using.....	5-1
Split frequency operation.....	4-10
Split Lock function.....	4-11
SQL level and RF gain.....	3-9
Supplied accessories.....	i

T	
Table of contents.....	v
Time Set.....	8-7
Tone Control.....	8-2
Touch panel display.....	1-4
Touch screen.....	iii
Touch screen operation.....	5-3
Trademarks.....	ii
Transmission, basic.....	3-9
Transmit filter width, setting.....	4-11
Transmit output power, adjusting.....	3-9
Transmitter.....	10-1
Transmitting and receiving.....	4-1
Tuning, manual.....	7-1
Tuning Step, changing.....	3-3
Tuning Step function.....	3-3
Tuning Step function, auto.....	3-4
Twin PBT, using.....	4-3
Twin Peak Filter.....	4-15

U	
Unmounting an SD card.....	6-2

V	
VFO A and VFO B, equalizing.....	3-1
VFO A or VFO B, selecting.....	3-1
VFO and Memory modes.....	3-1
VFO mode, using.....	3-1
VOICE DELAY.....	4-7
Volume level, adjusting.....	3-1
VOX function.....	4-7
Adjusting.....	4-7
Turning ON.....	4-7
VOX GAIN.....	4-7

W	
WIDTH.....	4-5



## INSTALLATION NOTES

For amateur base station installations it is recommended that the forward clearance in front of the antenna array is calculated relative to the EIRP (Effective Isotropic Radiated Power). The clearance height below the antenna array can be determined in most cases from the RF power at the antenna input terminals.

As different exposure limits have been recommended for different frequencies, a relative table shows a guideline for installation considerations.

Below 30 MHz, the recommended limits are specified in terms of V/m or A/m fields as they are likely to fall within the near-field region. Similarly, the antennas may be physically short in terms of electrical length and that the installation will require some antenna matching device which can create local, high intensity magnetic fields. Analysis of such MF installations is best considered in association with published guidance notes such as the FCC OET Bulletin 65 Edition 97-01 and its annexes relative to amateur transmitter installations. The EC recommended limits are almost identical to the FCC specified 'uncontrolled' limits and tables exist that show pre-calculated safe distances for different antenna types for different frequency bands. Further information can be found at <http://www.arrl.org/>.

### • Typical amateur radio installation

Exposure distance assumes that the predominant radiation pattern is forward and that radiation vertically downwards is at unity gain (sidelobe suppression is equal to main lobe gain). This is true of almost every gain antenna today. Exposed persons are assumed to be beneath the antenna array and have a typical height of 1.8 m.

The figures assume the worst case emission of a constant carrier.

For the bands 10 MHz and higher the following power density limits have been recommended:

10–50 MHz 2 W/sq m

### Vertical clearance by EIRP output

1 Watts 2.1 m  
 10 Watts 2.8 m  
 25 Watts 3.4 m  
 100 Watts 5 m  
 1000 Watts 12 m

### Forward clearance by EIRP output

100 Watts 2 m  
 1000 Watts 6.5 m  
 10,000 Watts 20 m  
 100,000 Watts 65 m

In all cases any possible risk depends on the transmitter being activated for long periods. (actual recommendation limits are specified as an average during 6 minutes)  
 Normally the transmitter is not active for long periods of time. Some radio licenses will require that a timer circuit automatically cuts the transmitter after 1–2 minutes etc.

Similarly some types of emission, i.e., SSB, CW, AM etc. have a lower 'average' output power and the assessed risk is even lower.

### • List of Country codes (ISO 3166-1)

	Country	Codes		Country	Codes
1	Austria	AT	18	Liechtenstein	LI
2	Belgium	BE	19	Lithuania	LT
3	Bulgaria	BG	20	Luxembourg	LU
4	Croatia	HR	21	Malta	MT
5	Czech Republic	CZ	22	Netherlands	NL
6	Cyprus	CY	23	Norway	NO
7	Denmark	DK	24	Poland	PL
8	Estonia	EE	25	Portugal	PT
9	Finland	FI	26	Romania	RO
10	France	FR	27	Slovakia	SK
11	Germany	DE	28	Slovenia	SI
12	Greece	GR	29	Spain	ES
13	Hungary	HU	30	Sweden	SE
14	Iceland	IS	31	Switzerland	CH
15	Ireland	IE	32	Turkey	TR
16	Italy	IT	33	United Kingdom	GB
17	Latvia	LV			

Count on us!

IC-7300 #03  
(Europe)

< Intended Country of Use >	
<input checked="" type="checkbox"/>	AT
<input checked="" type="checkbox"/>	BE
<input checked="" type="checkbox"/>	CY
<input checked="" type="checkbox"/>	CZ
<input checked="" type="checkbox"/>	DK
<input checked="" type="checkbox"/>	EE
<input checked="" type="checkbox"/>	FI
<input checked="" type="checkbox"/>	FR
<input checked="" type="checkbox"/>	DE
<input checked="" type="checkbox"/>	GR
<input checked="" type="checkbox"/>	HU
<input checked="" type="checkbox"/>	IE
<input checked="" type="checkbox"/>	IT
<input checked="" type="checkbox"/>	LV
<input checked="" type="checkbox"/>	LT
<input checked="" type="checkbox"/>	LU
<input checked="" type="checkbox"/>	MT
<input checked="" type="checkbox"/>	NL
<input checked="" type="checkbox"/>	PL
<input checked="" type="checkbox"/>	PT
<input checked="" type="checkbox"/>	SK
<input checked="" type="checkbox"/>	SI
<input checked="" type="checkbox"/>	ES
<input checked="" type="checkbox"/>	SE
<input checked="" type="checkbox"/>	GB
<input checked="" type="checkbox"/>	IS
<input checked="" type="checkbox"/>	LI
<input checked="" type="checkbox"/>	NO
<input checked="" type="checkbox"/>	CH
<input checked="" type="checkbox"/>	BG
<input checked="" type="checkbox"/>	RO
<input checked="" type="checkbox"/>	TR
<input checked="" type="checkbox"/>	HR

IC-7300 #05  
(Italy)

< Intended Country of Use >	
<input type="checkbox"/>	AT
<input type="checkbox"/>	BE
<input type="checkbox"/>	CY
<input type="checkbox"/>	CZ
<input type="checkbox"/>	DK
<input type="checkbox"/>	EE
<input type="checkbox"/>	FI
<input type="checkbox"/>	FR
<input type="checkbox"/>	DE
<input type="checkbox"/>	GR
<input type="checkbox"/>	HU
<input type="checkbox"/>	IE
<input checked="" type="checkbox"/>	IT
<input type="checkbox"/>	LV
<input type="checkbox"/>	LT
<input type="checkbox"/>	LU
<input type="checkbox"/>	MT
<input type="checkbox"/>	NL
<input type="checkbox"/>	PL
<input type="checkbox"/>	PT
<input type="checkbox"/>	SK
<input type="checkbox"/>	SI
<input type="checkbox"/>	ES
<input type="checkbox"/>	SE
<input type="checkbox"/>	GB
<input type="checkbox"/>	IS
<input type="checkbox"/>	LI
<input type="checkbox"/>	NO
<input type="checkbox"/>	CH
<input type="checkbox"/>	BG
<input type="checkbox"/>	RO
<input type="checkbox"/>	TR
<input type="checkbox"/>	HR

IC-7300 #06  
(Spain)

< Intended Country of Use >	
<input type="checkbox"/>	AT
<input type="checkbox"/>	BE
<input type="checkbox"/>	CY
<input type="checkbox"/>	CZ
<input type="checkbox"/>	DK
<input type="checkbox"/>	EE
<input type="checkbox"/>	FI
<input type="checkbox"/>	FR
<input type="checkbox"/>	DE
<input type="checkbox"/>	GR
<input type="checkbox"/>	HU
<input type="checkbox"/>	IE
<input type="checkbox"/>	IT
<input type="checkbox"/>	LV
<input type="checkbox"/>	LT
<input type="checkbox"/>	LU
<input type="checkbox"/>	MT
<input type="checkbox"/>	NL
<input type="checkbox"/>	PL
<input type="checkbox"/>	PT
<input type="checkbox"/>	SK
<input type="checkbox"/>	SI
<input checked="" type="checkbox"/>	ES
<input type="checkbox"/>	SE
<input type="checkbox"/>	GB
<input type="checkbox"/>	IS
<input type="checkbox"/>	LI
<input type="checkbox"/>	NO
<input type="checkbox"/>	CH
<input type="checkbox"/>	BG
<input type="checkbox"/>	RO
<input type="checkbox"/>	TR
<input type="checkbox"/>	HR